

Features:

Application:

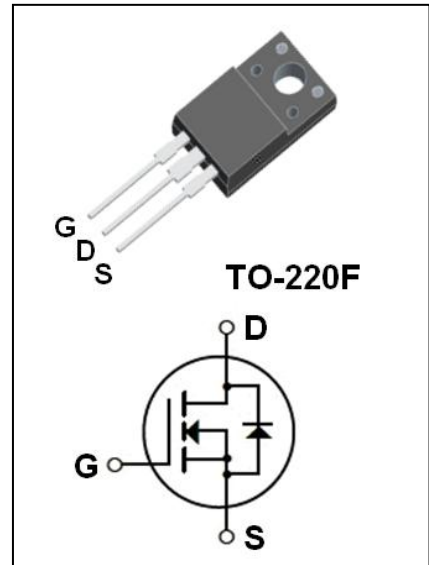

**Absolute Maximum Ratings**

|  |     |   |   |
|--|-----|---|---|
|  |     |   |   |
|  |     |   |   |
|  | °   |   |   |
|  |     |   |   |
|  |     | ± |   |
|  |     |   |   |
|  |     |   |   |
|  | ° ) |   | ° |
|  |     |   | ° |
|  |     |   | ° |

\*

**Thermal Characteristics**

|  |  |  |   |
|--|--|--|---|
|  |  |  |   |
|  |  |  | ° |
|  |  |  | ° |

**Electrical Characteristics** ○

|   |  |   |  |  |  |   |
|---|--|---|--|--|--|---|
|   |  |   |  |  |  |   |
| <b>Off Characteristics</b>                                    |  |   |  |  |  |   |
|   |  |   |  |  |  |   |
| △   |  | ○ |  |  |  | ○ |
| △   |  |   |  |  |  |   |
|   |  | ○ |  |  |  |   |
|   |  |   |  |  |  |   |
|   |  |   |  |  |  |   |
| <b>On Characteristics</b>                                     |  |   |  |  |  |   |
|   |  |   |  |  |  |   |
|   |  |   |  |  |  |   |
|   |  |   |  |  |  |   |
| <b>Dynamic Characteristics</b>                                |  |   |  |  |  |   |
|   |  |   |  |  |  |   |
|   |  |   |  |  |  |   |
|   |  |   |  |  |  |   |
| <b>Switching Characteristics</b>                              |  |   |  |  |  |   |
|   |  |   |  |  |  |   |
|   |  |   |  |  |  |   |
|   |  |   |  |  |  |   |
|   |  |   |  |  |  |   |
|   |  |   |  |  |  |   |
|   |  |   |  |  |  |   |
|   |  |   |  |  |  |   |
| <b>Drain-Source Diode Characteristics and Maximum Ratings</b> |  |   |  |  |  |   |
|   |  |   |  |  |  |   |
|   |  |   |  |  |  |   |
|   |  |   |  |  |  |   |
|   |  |   |  |  |  |   |
|   |  |   |  |  |  |   |

、  
、  
、  
、  
、  
、

○ ○  
○

### On-Regin Characteristics

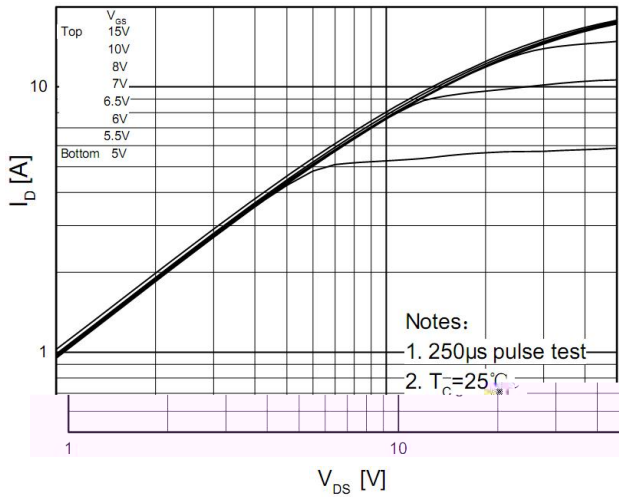

### Transfer Characteristics

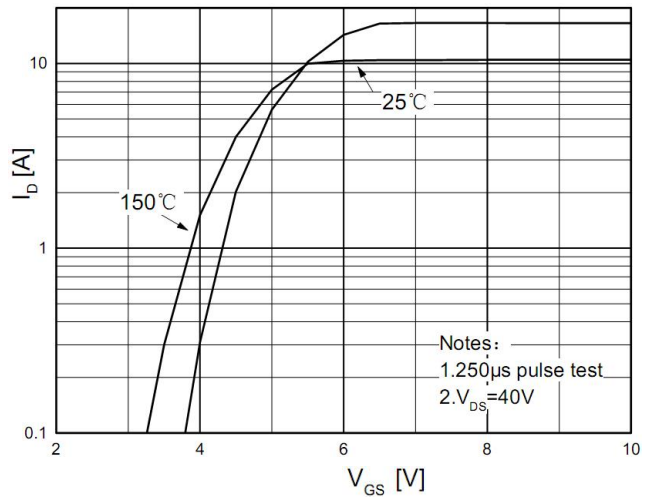

### On-Resistance Variation vs. Drain Current and Gate Voltage

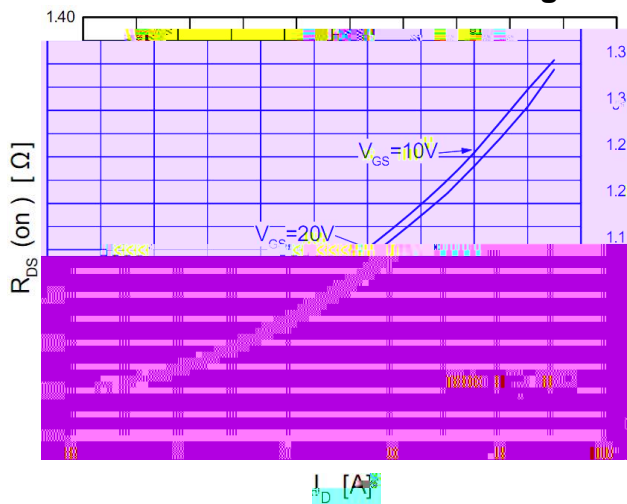

### Body Diode Forward Voltage Variation vs. Source Current and Temperature

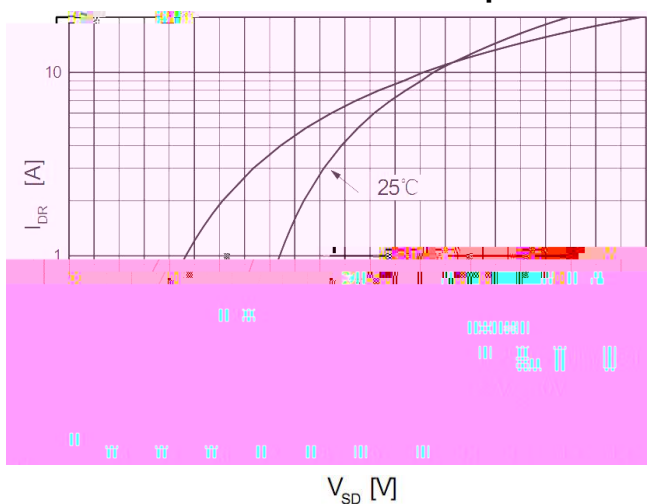

### Capacitance Characteristics

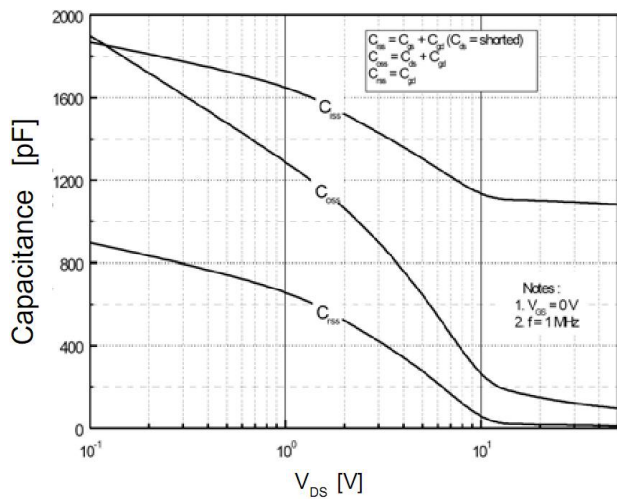

### Gate Charge Characteristics

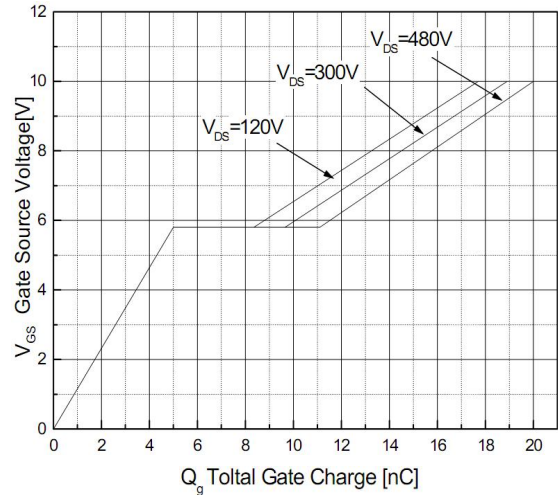

**Breakdown Voltage Variation vs. Temperature**

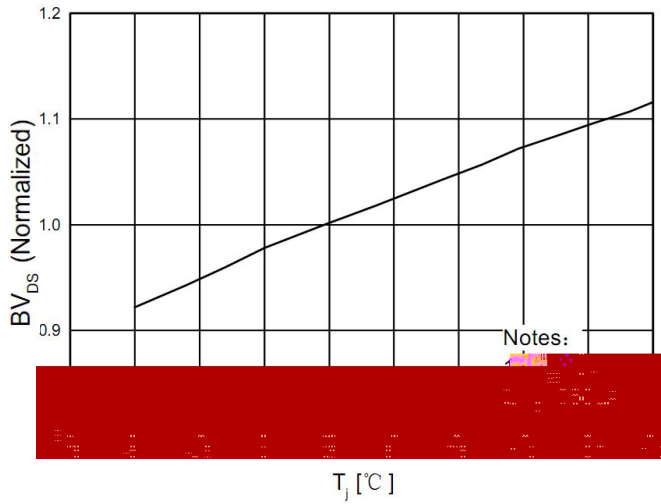

**On-Resistance Variation vs. Temperature**

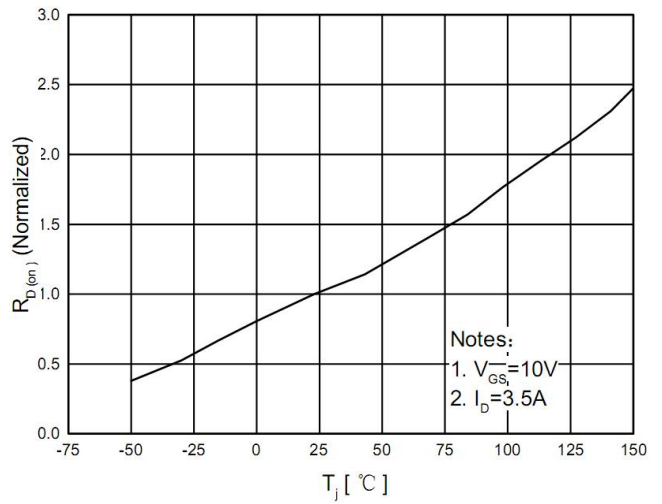

**Maximum Safe Operating Area**

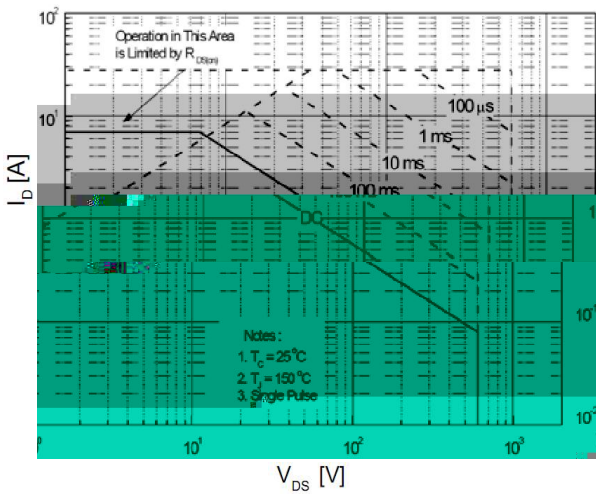

**Maximum Drain Current Vs. Case Temperature**

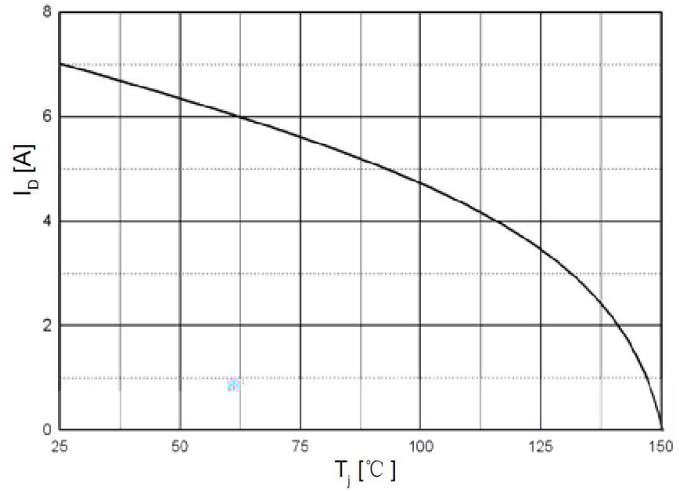

# TO-220F Package Dimensions

:

