



深圳市弗瑞鑫电子有限公司

规格承认书

—

prepare	
check	
approve	



TRX电容一级代理商
深圳市弗瑞鑫电子有限公司

Add: 深圳市宝安区西乡大道302号金源商务大厦B座3楼

Tel: 0755-29563634

Fax: 0755-27447020

SMD Y
SMD Y1 a.c. ceramic capacitors



/Number

/Date

/Edition

/Page



SMD Y
SMD Y1 a.c. ceramic capacitors

/Number		/Date	
/Edition		/Page	

1. /Product Name





T M Y1 101 K
 ① ② ③ ④ ⑤

①			
②			
③			
④			
⑤			

2. /Product marking

--

 TRX 专注电容器廿年	SMD Y		
	SMD Y1 a.c. ceramic capacitors		
	/Number		/Date
/Edition		/Page	

/Explanation	
	
	
	
	
	

3. /Date code

↓	↓				
		↓	↓		

4. /Certificates

certificates			

5. / Product structure

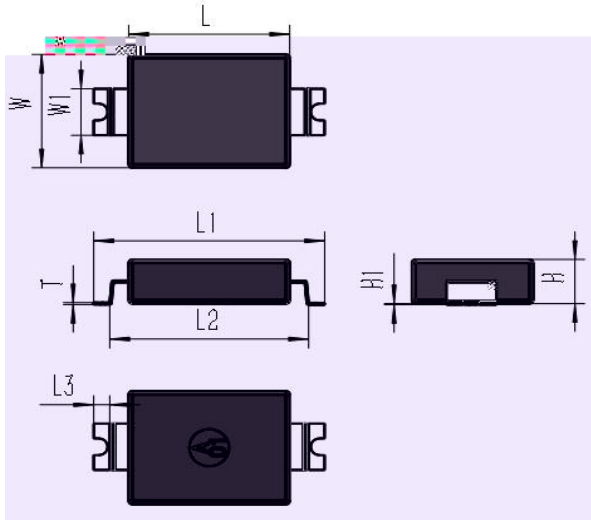

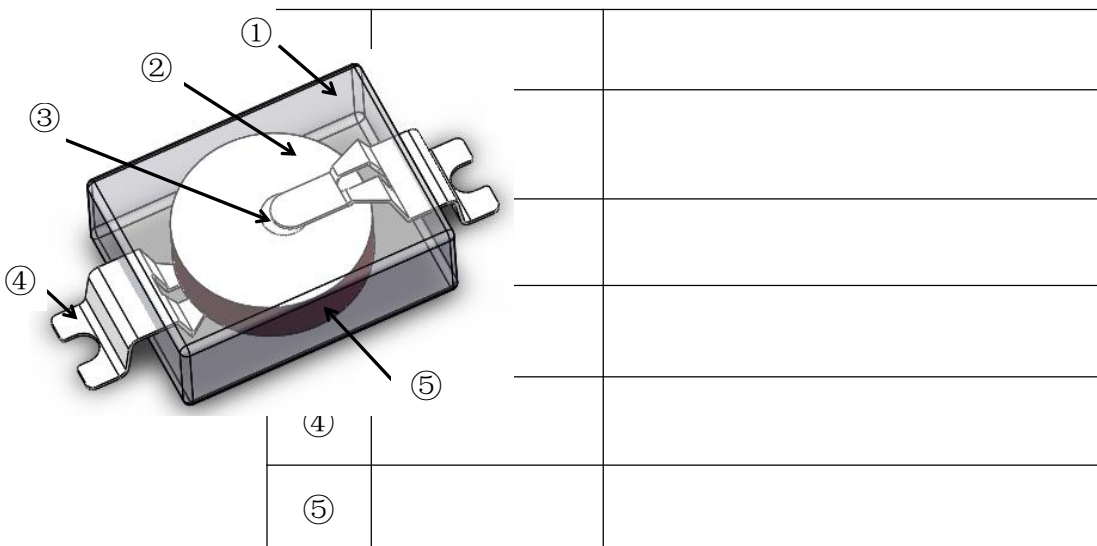

/Number		/Date	
/Edition		/Page	

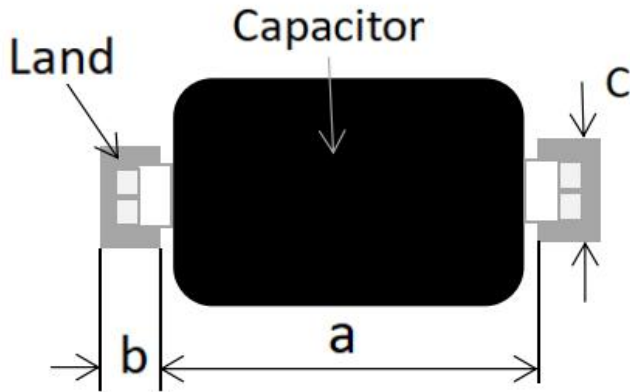

6. / Soldering condition

/

°
°C
°
°

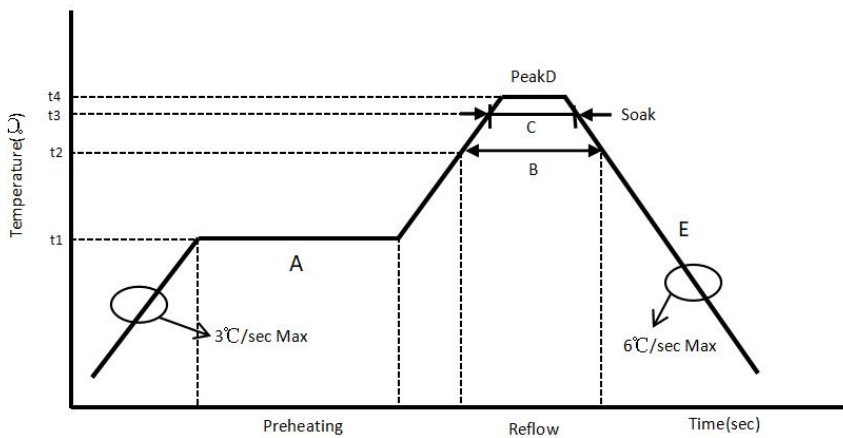

	SMD Y SMD Y1 a.c. ceramic capacitors		
	/Number		/Date
	/Edition		/Page

/

°
°C
°
°
°

/

7. / Performance and test methods

 TRX 专注电容器廿年	SMD Y SMD Y1 a.c. ceramic capacitors		
	/Number		/Date
	/Edition		/Page





SMD Y
SMD Y1 a.c. ceramic capacitors

/Number

/Date

/Edition

/Page



SMD Y
SMD Y1 a.c. ceramic capacitors

/Number

/Date

/Edition

/Page

		△	
		△	
		△	
		△	
		△	
		△	
		△	
		△	
		△	
		△	



SMD Y
SMD Y1 a.c. ceramic capacitors

/Number

/Date

/Edition

/Page

--	--	--	--

 TRX 专注电容器廿年	SMD Y SMD Y1 a.c. ceramic capacitors			
	/Number		/Date	
	/Edition		/Page	



 TRX 专注电容器廿年	SMD Y SMD Y1 a.c. ceramic capacitors			
	/Number		/Date	
	/Edition		/Page	

11. /Prod

 TRX 专注电容器廿年	SMD Y SMD Y1 a.c. ceramic capacitors		
	/Number		/Date
	/Edition		/Page

/inner-packaging

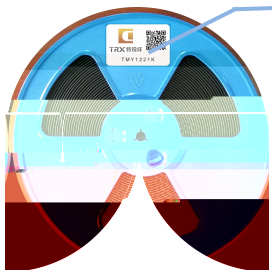

标签



料号

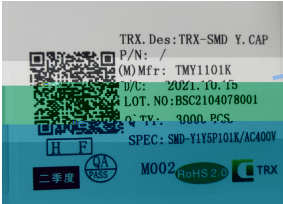

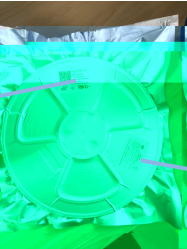

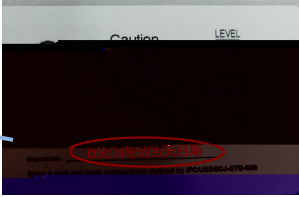

/Outer-packaging





图示 /



图示 /



图示 /

/Package sketch:



/



/





Remark

	SMD Y SMD Y1 a.c. ceramic capacitors			
	/Number		/Date	
	/Edition		/Page	

12. /Application notes

①

②

③

④

⑤

⑥