一级代理商：

深圳市弗瑞鑫电子有限公司

地址：深圳市宝安区西乡大道302号金源商务大厦B座三楼

frxelec

1.



2.

3.

4.

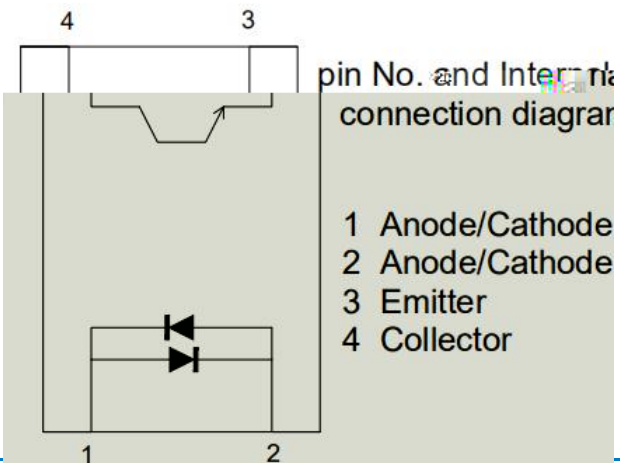

5.

6.

ДБ



λ
»
Λ
0

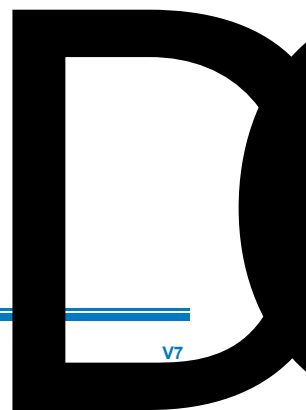

7.

8.

9.

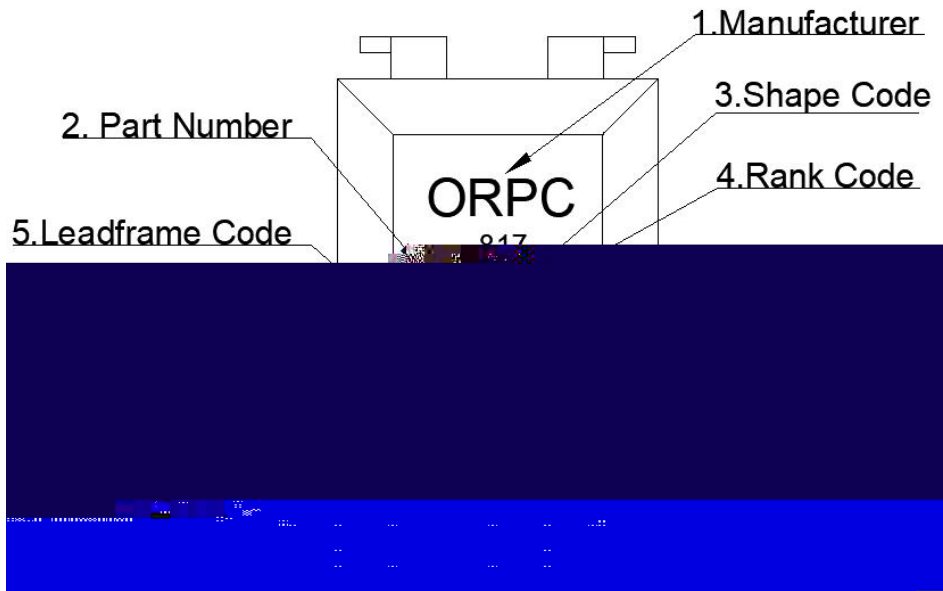

10.

1.

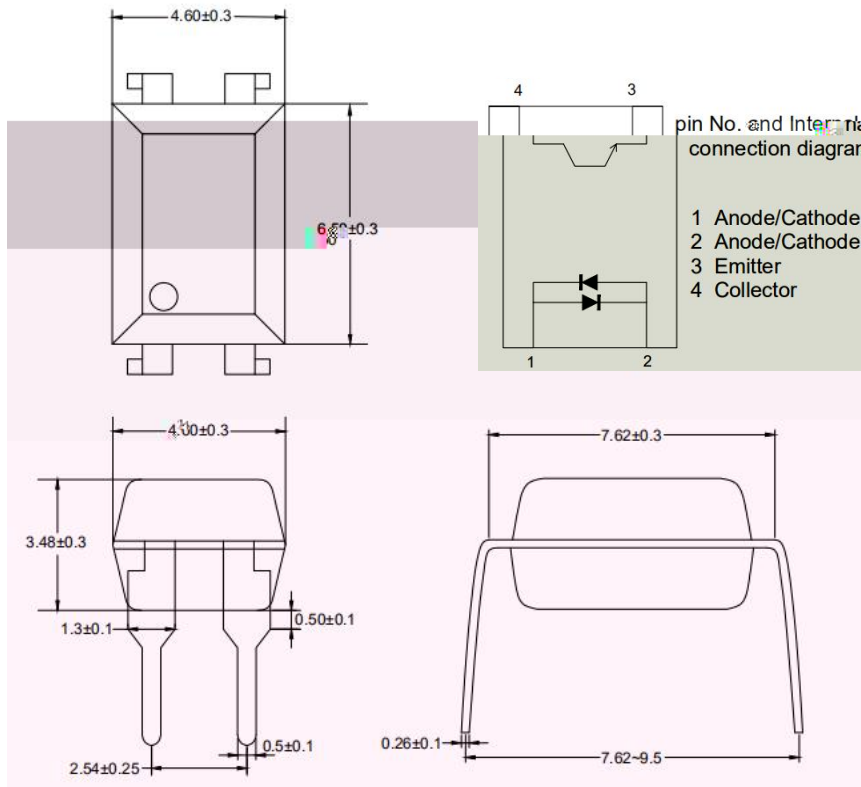

2.

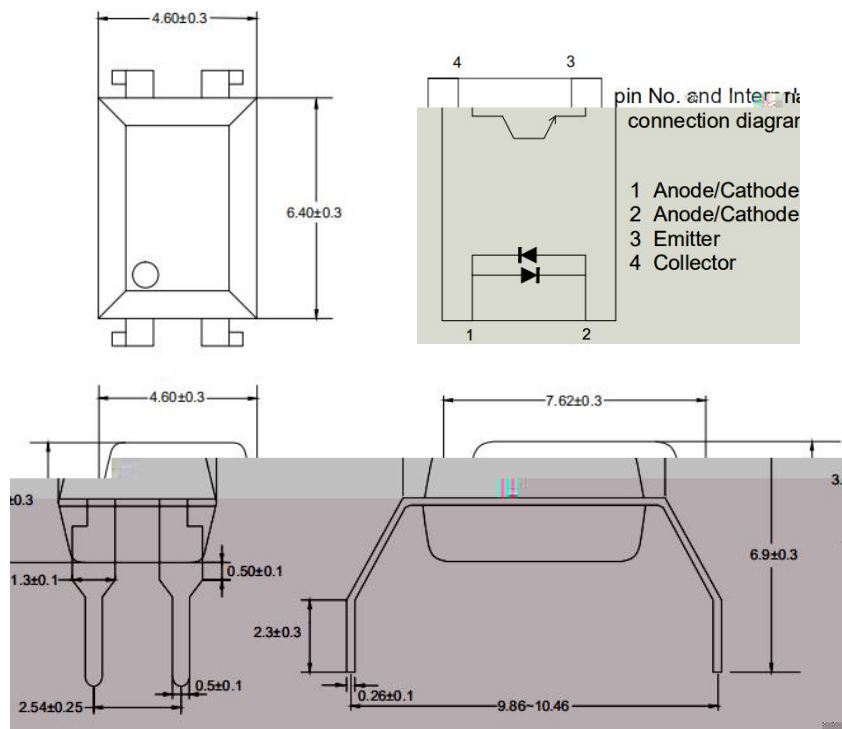

3.

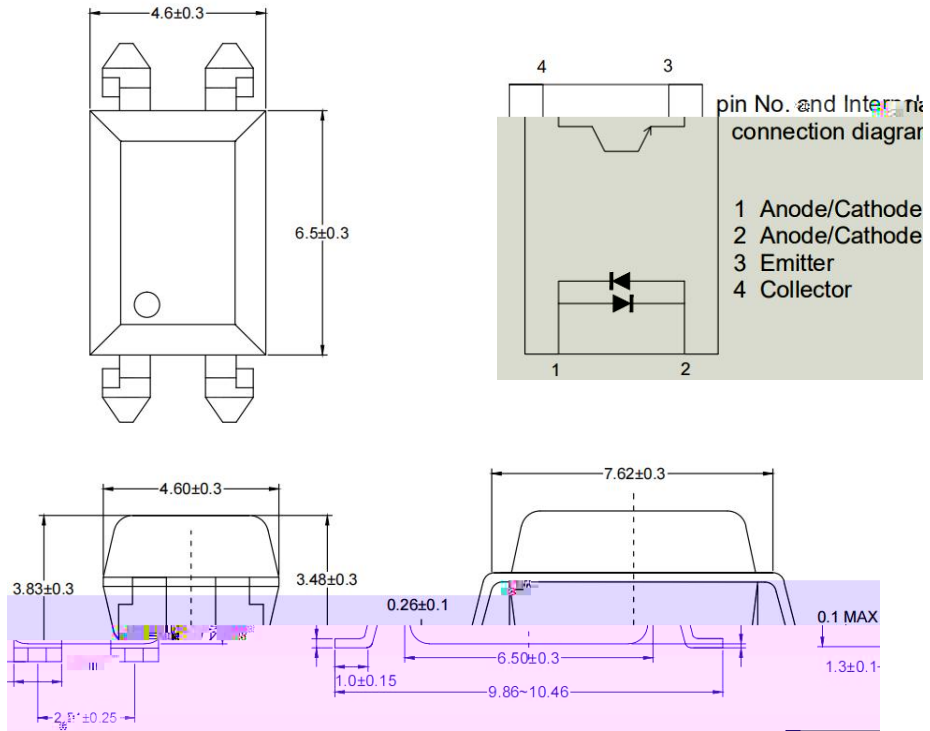

11.

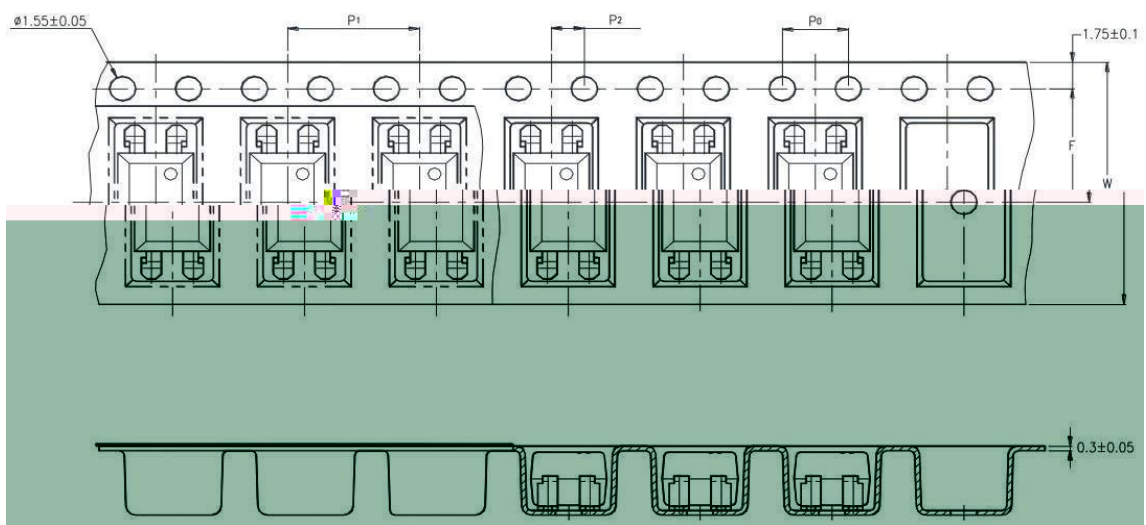

12.

14.



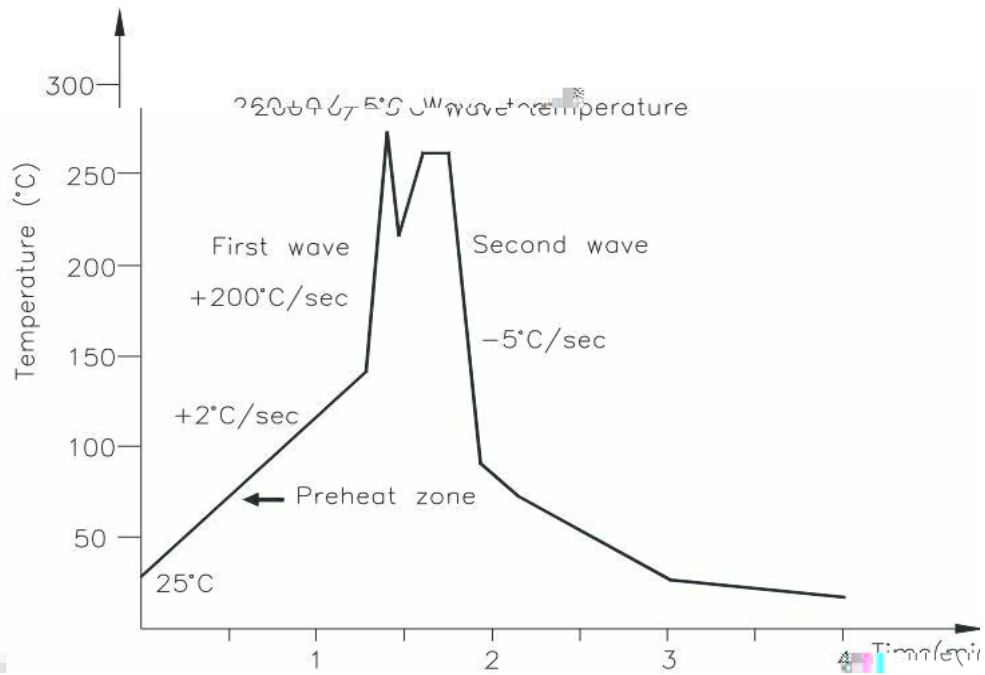

Temperature	380+0/-5°C
Time	3 sec max

16.

Fig.1 Forward current vs Ambient temperature

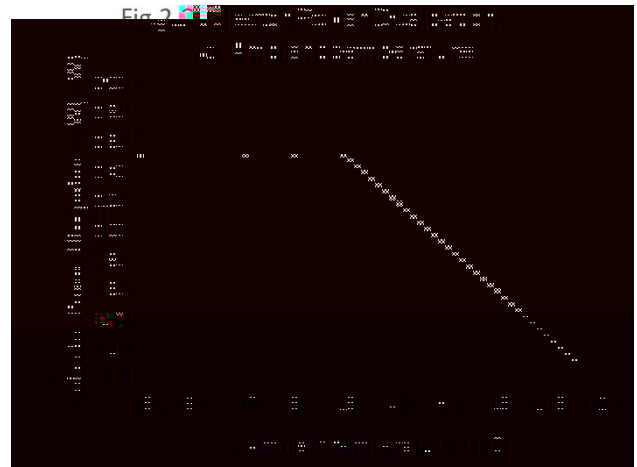
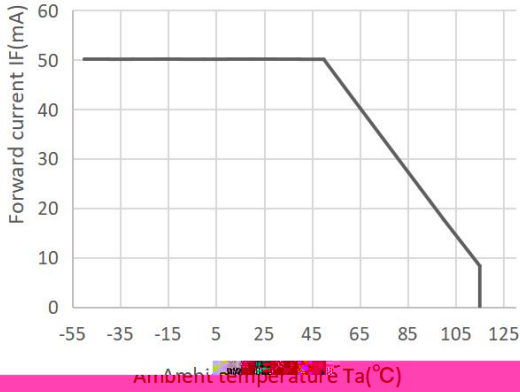

Fig.3 Collector-emitter Saturation Voltage vs. Forward Current

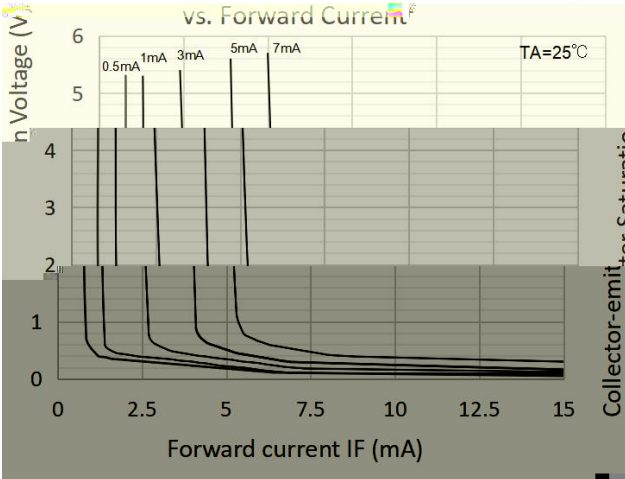

Fig.4 Forward Current vs. Forward Voltage

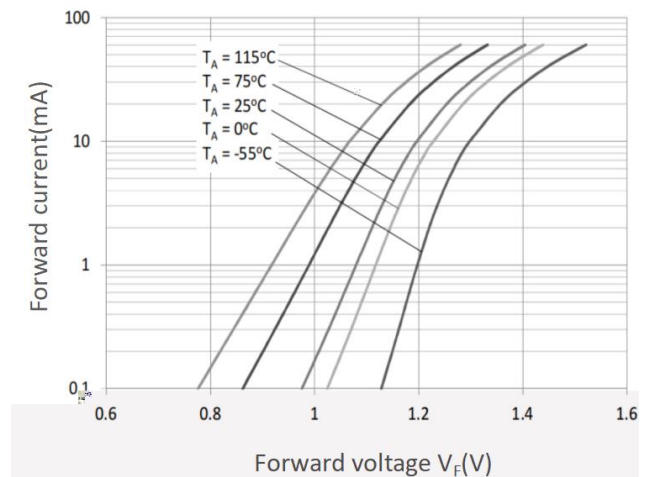

Fig.5 Forward Current vs. Current Transfer Ratio

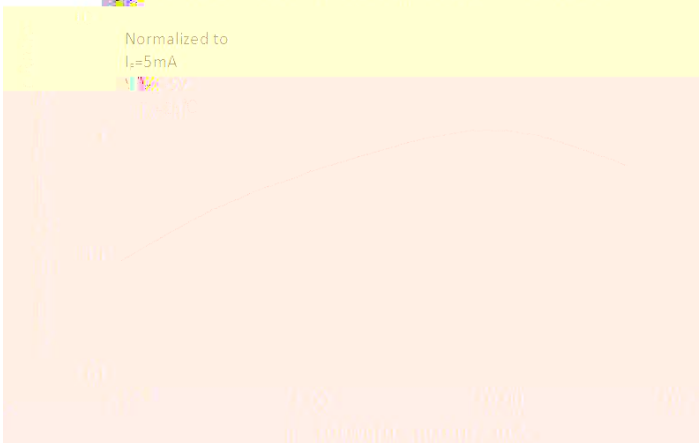

Fig.6 Collector Current vs. Collector-emitter Voltage

