

BAW56

Features

- Small package
- Low forward voltage
- Fast reverse recovery time
- Small total capacitance

Applications

- Ultra high speed switching application

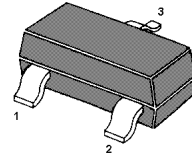
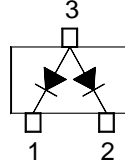

SOT-23 Plastic Package

Absolute Maximum Ratings ($T_a = 25\text{ }^\circ\text{C}$)

Parameter	Symbol	Value	Unit
Peak Repetitive Reverse Voltage	V_{RRM}	85	V
Continuous Reverse Voltage	V_R	75	V
Forward Current (DC)	I_F	215 125	mA
Repetitive Peak Forward Current	I_{FRM}	450	mA
Non-repetitive Peak Forward Surge Current	I_{FSM}	0.5 1 4	A

Powe



BAW56

Silicon Epitaxial Planar Switching Diode

Typical Characteristics

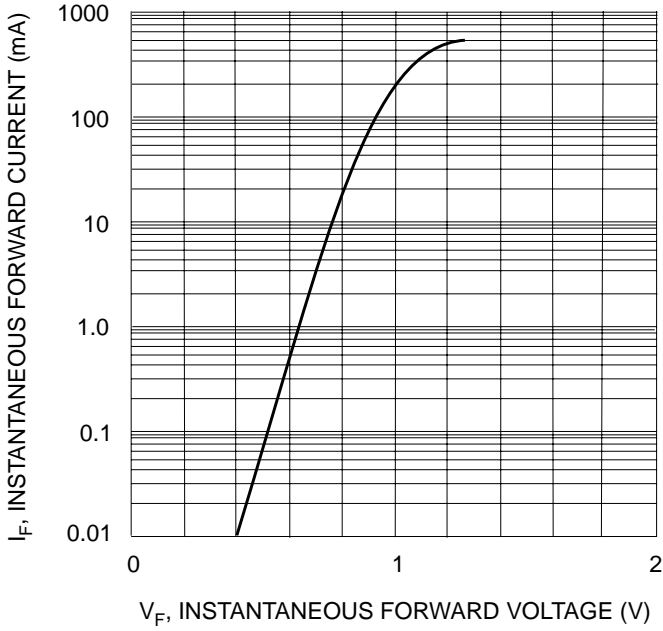

Fig. 1 Forward Characteristics

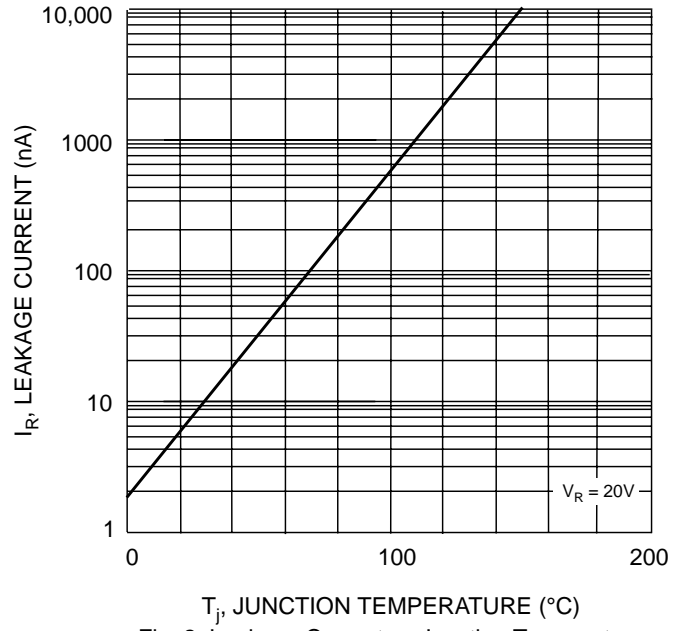

Fig. 2 Leakage Current vs Junction Temperature

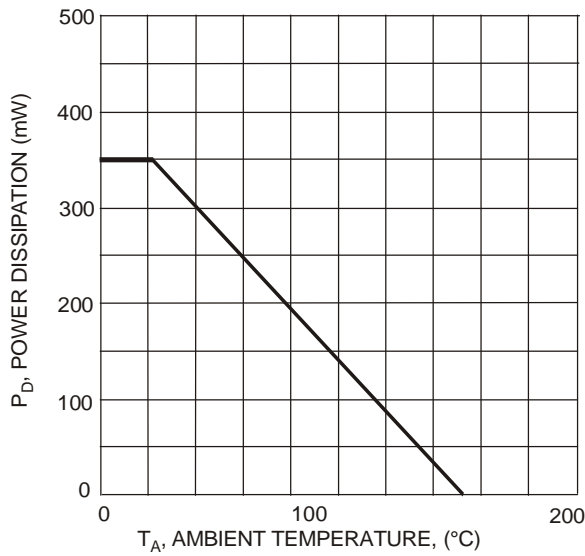
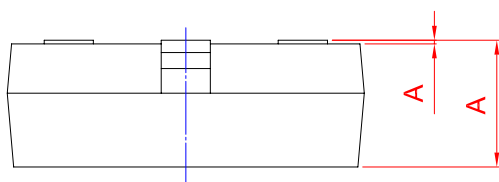
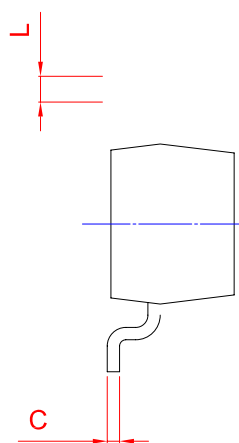
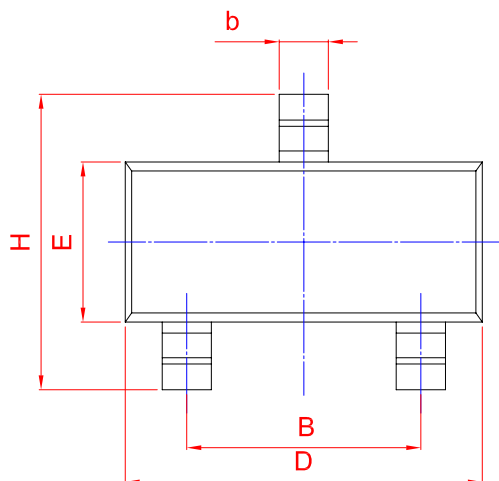
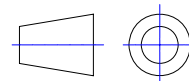

Fig. 3 Power Derating Curve, Total Package



UNIT	A				D	E		A1	
mm	1.40		0.50	0.19	3.10				
	0.95		0.35	0.08	2.70				