



YJL3400A

N-Channel Enhancement Mode Field Effect Transistor

Product Summary

V_{DS}	30V
I_D	5.6A
$R_{DS(ON)}$ (at $V_{GS}=10V$)	25mo



YJL3400A

Electrical Characteristics (T_J=25 unless otherwise noted)

Parameter	Symbol	Conditions	Min	Typ	Max	Units
Static Parameter						
Drain-Source Breakdown Voltage	BV _{DSS}	V _{GS} =0V, I _D =250 A	30			V
Zero Gate Voltage Drain Current	I _{DSS}	V _{DS} =30V, V _{GS} =0V			1	A
Gate-Body Leakage Current	I _{GSS1}	V _{GS} = 12V, V _{DS} =0V			100	nA
Gate Threshold Voltage	V _{GS(th)}	V _{DS} = V _{GS} , I _D =250 A	0.65	0.9	1.5	V
Static Drain-Source On-Resistance	R _{DS(ON)}	V _{GS} =10V, I _D =5.6A		20	25	m
		V _{GS} =4.5V, I _D =5A		23	31	
		V _{GS} =2.5V, I _D =3A		27	45	
Diode Forward Voltage	V _{SD}	I _S =5.6A, V _{GS} =0V			1.2	V
Dynamic Parameters						
Input Capacitance	C _{iss}	V _{DS} =15V, V _{GS} =0V, f=1MHZ		630		pF
Output Capacitance	C _{oss}			55		
Reverse Transfer Capacitance	C _{rss}			71		
Switching Parameters						
Total Gate Charge	Q _g	V _{GS} =10V, V _{DS} =15V, I _D =5.6A		17.25		nC
Gate-Source Charge	Q _{gs}			2.1		
Gate-Drain Charge	Q _{gd}			2		
Reverse Recovery Charge	Q _{rr}	I _F =5.6A, di/dt=100A/us		1.1		ns
Reverse Recovery Time	t _{rr}			13.1		
Turn-on Delay Time	t _{D(on)}	V _{GS} =10V, V _{DS} =15V, I _D =5.6A R _{GEN} =3		4.4		ns
Turn-on Rise Time	t _r			28.2		
Turn-off Delay Time	t _{D(off)}			16.2		
Turn-off fall Time	t _f			26		

A. Pulse Test: Pulse Width 300us, Duty cycle 2%.

B. R_{JA} is the sum of the junction-to-case and case-to-ambient thermal resistance, where the case thermal reference is defined as the solder mounting surface of the drain pins. R_{JC} is guaranteed by design, while R_{JA} is determined by the board design. The maximum rating presented here is based on mounting on a 1 in 2 pad of 2oz copper.



Typical Performance Characteristics

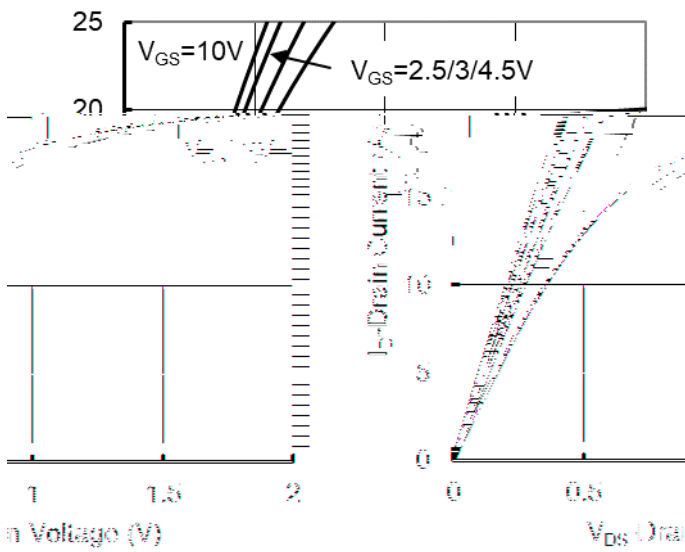

Figure1. Output Characteristics

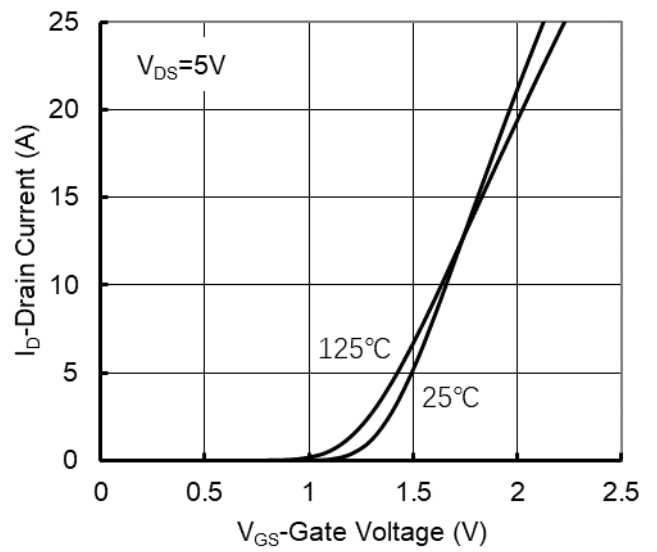

Figure2. Transfer Characteristics

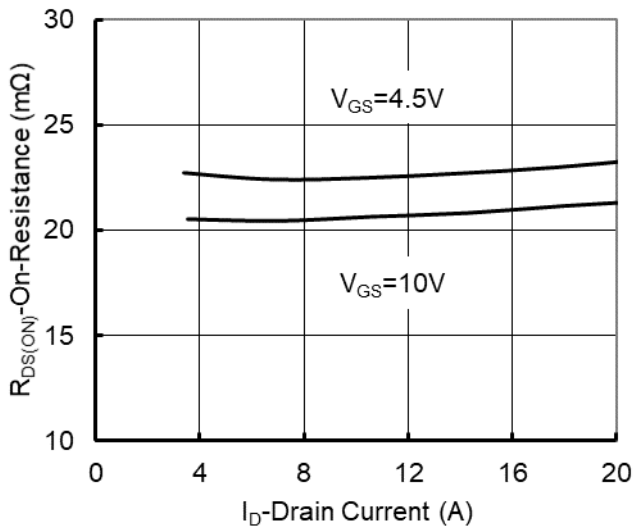

Figure 3: On-Resistance vs. Drain Current and Gate Voltage

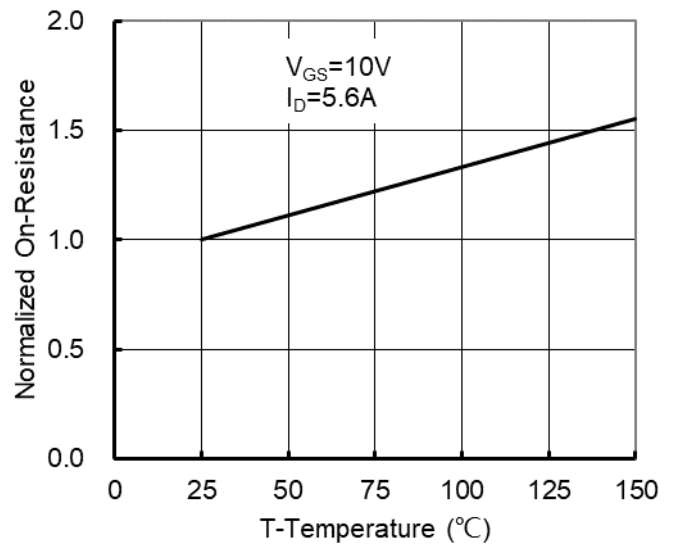

Figure 4: On-Resistance vs. Junction Temperature

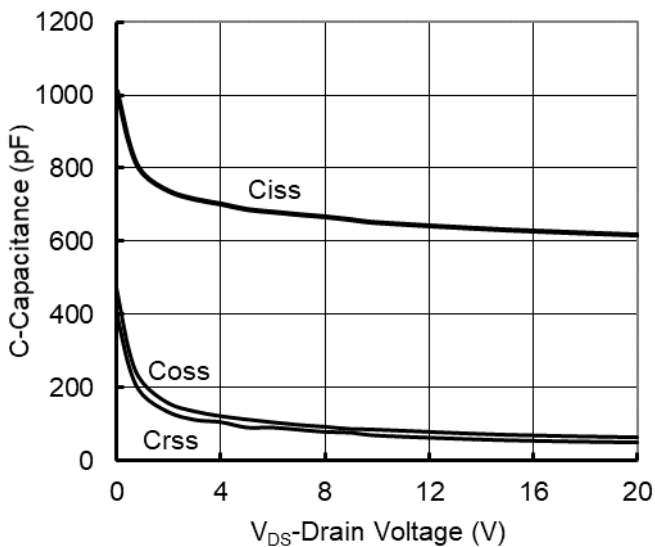

Figure5. Capacitance Characteristics

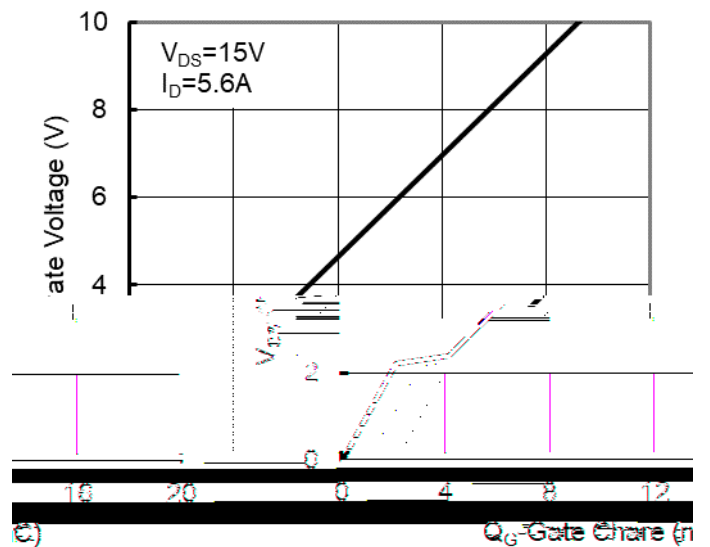

Figure6. Gate Charge



YJL3400A

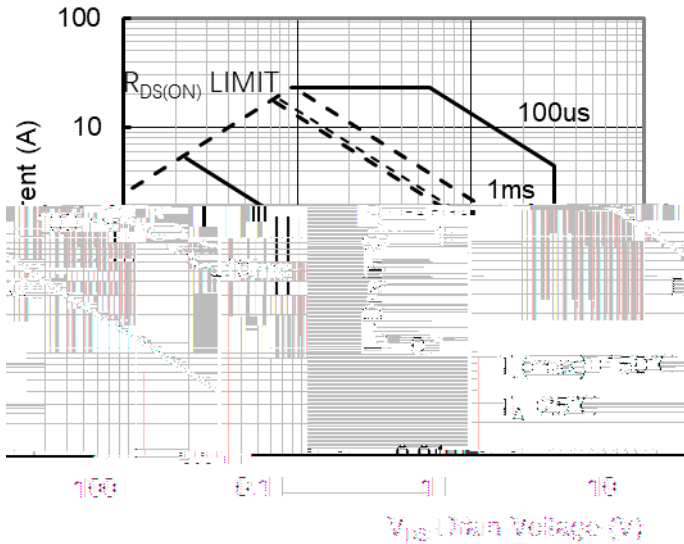

Figure7. Safe Operation Area

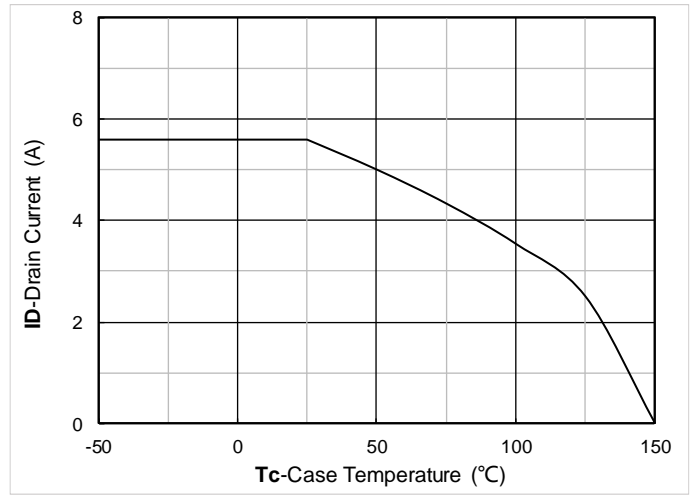

Figure8. Current dissipation

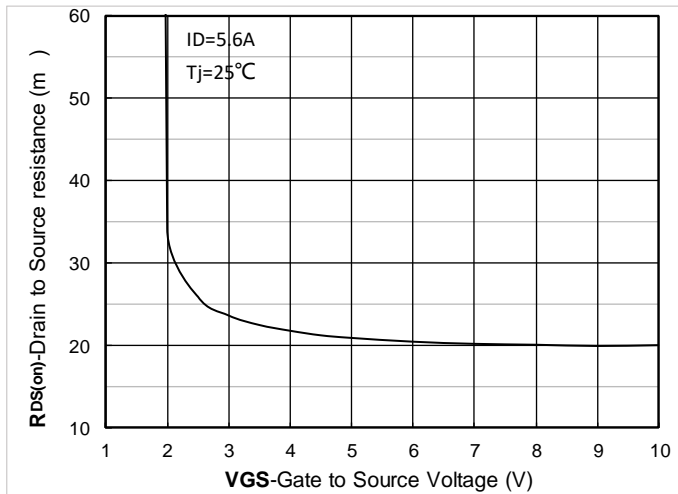

Figure 9. On-Resistance vs Gate to Source Voltage

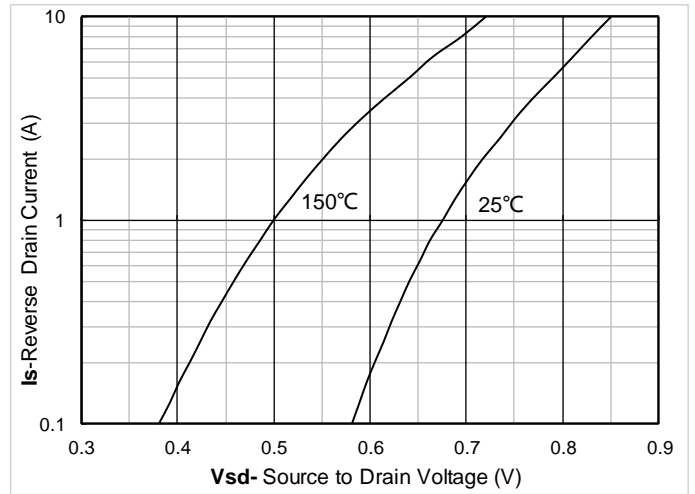

Figure 10. Forward characteristics of reverse diode

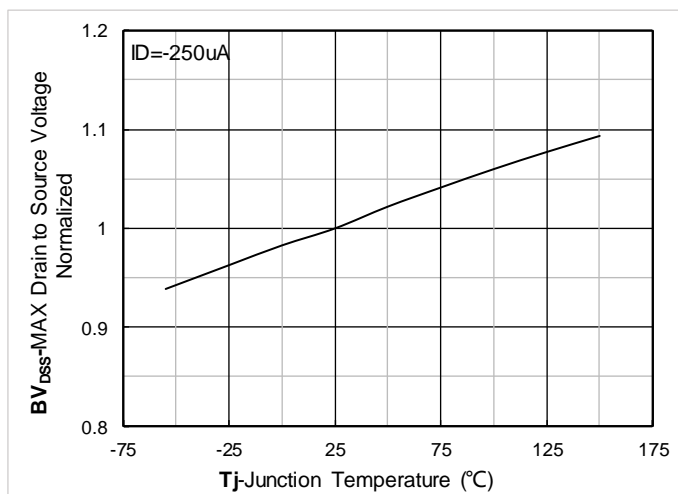

Figure 11. Normalized breakdown voltage

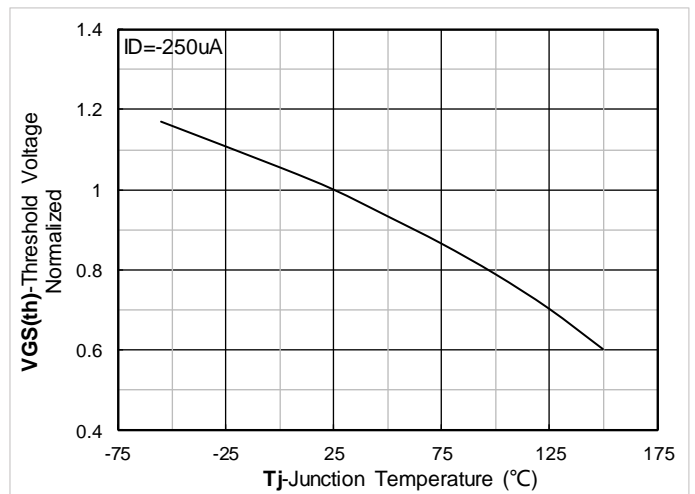

Figure 12. Normalized Threshold voltage



YJL3400A

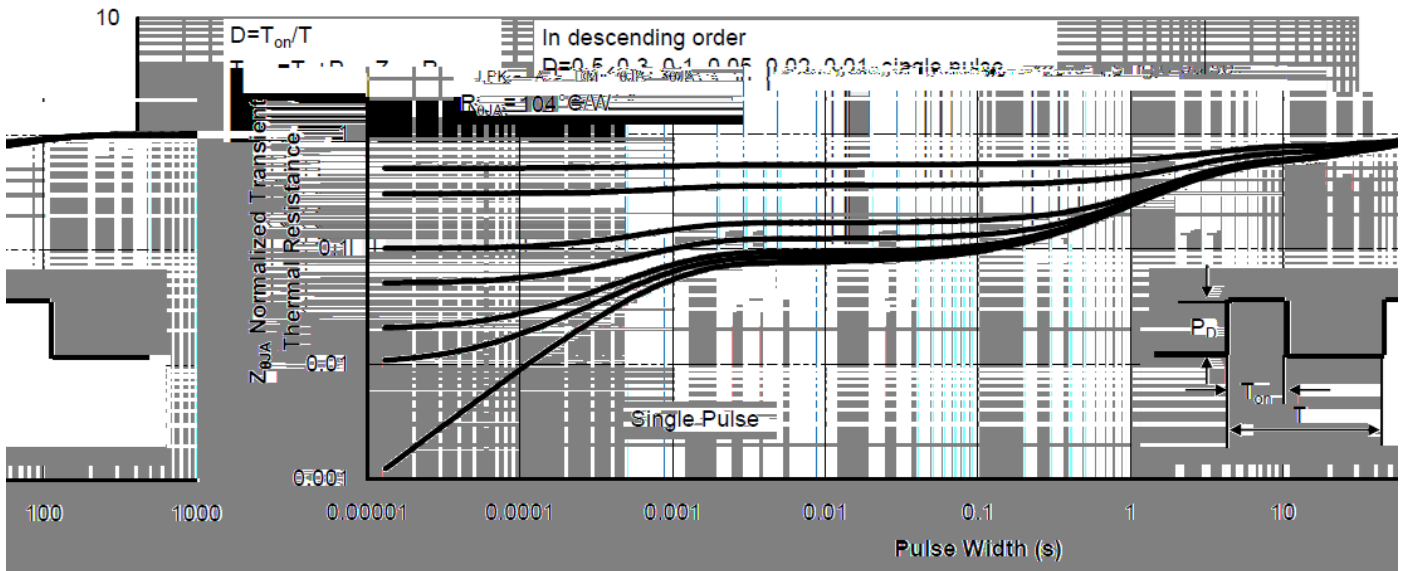
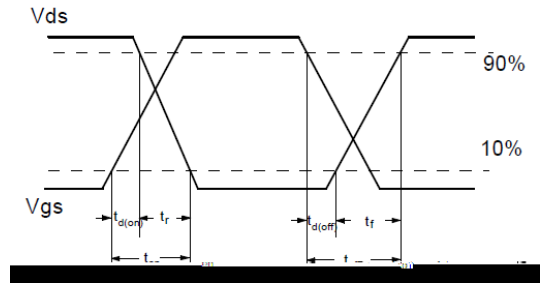
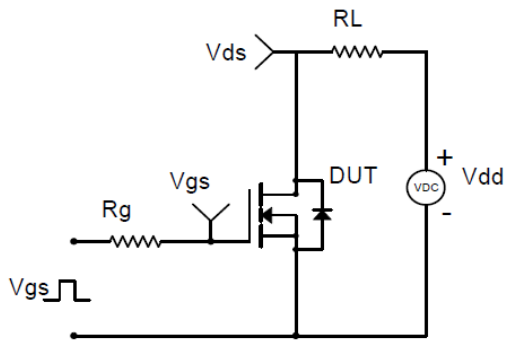
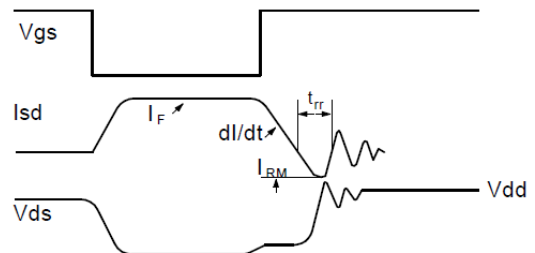
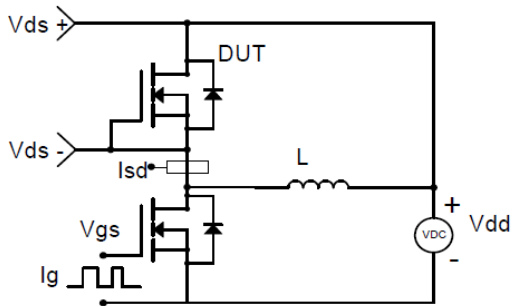

Figure 13. Normalized Maximum Transient Thermal Impedance



Resistive Switching Test Circuit & Waveforms



Diode Recovery Test Circuit & Waveforms

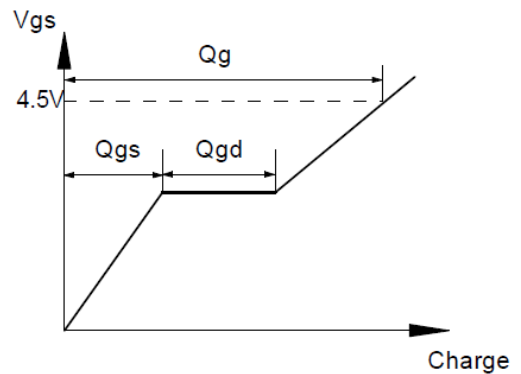
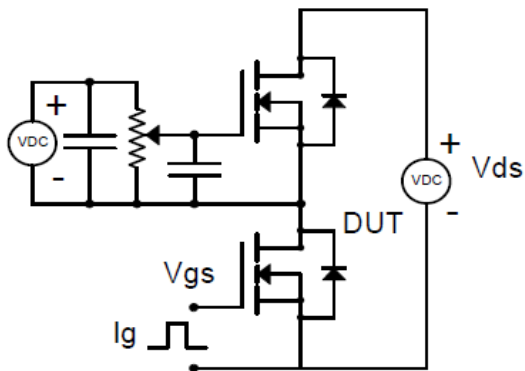

Gate Charge Test Circuit & Waveform

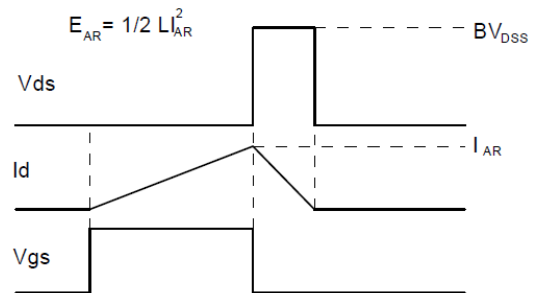
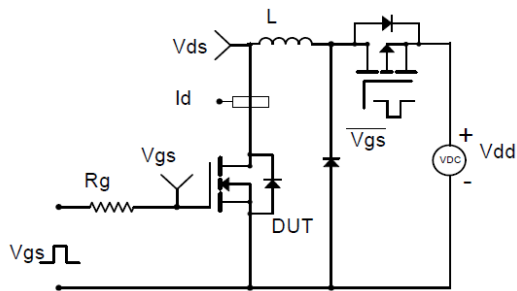

Unclamped Inductive Switching (UIS) Test Circuit & Waveforms



YJL3400A

SOT-23 Package information

TOP VIEW

SIDE VIEW



SIDE VIEW

UNIT mm

SUGGESTED SOLDER PAD LAYOUT

NOTE:

- 1.PACKAGE BODY SIZES EXCLUDE MOLD FLASH AND GATE BURRS.
- 2.TOLERANCE 0.1mm UNLESS OTHERWISE SPECIFIED.
- 3.THE PAD LAYOUT IS FOR REFERENCE PURPOSES ONLY.



YJL3400A

Disclaimer

The information presented in this document is for reference only. Yangzhou Yangjie Electronic Technology Co., Ltd. reserves the right to make changes without notice for the specification of the products displayed herein to improve reliability, function or design or otherwise.

The product listed herein is designed to be used with ordinary electronic equipment or devices, and not designed to be used with equipment or devices which require high level of reliability and the malfunction of which would directly endanger human life (such as medical instruments, transportation equipment, aerospace machinery, nuclear-reactor controllers, fuel controllers and other safety devices), Yangjie or anyone on its behalf, assumes no responsibility or liability for any damages resulting from such improper use of sale.

This publication supersedes & replaces all information previously supplied. For additional information, please visit our website [http:// www.frxelec.com](http://www.frxelec.com), or consult your nearest Yangjie's sales office for further assistance.