

Silicon Carbide Schottky Diode

V_{RRM}	650 V
I_F 135°C	6.5 A
Q_C	12 nC

Features

- Positive temperature coefficient
- Temperature-independent switching
- Maximum working temperature at 175 °C
- Unipolar devices and zero reverse recovery current
- Zero forward recovery current
- Essentially no switching losses
- Reduction of heat sink requirements
- High-frequency operation
- Reduction of EMI

Typical Applications

Typical applications are in power factor correction(PFC), solar inverter, uninterruptible power supply, motor drives, photovoltaic inverter, electric car and charger.

Mechanical Data

Package: TO-220AC

Molding compound meets UL 94 V-0 flammability rating, RoHS-compliant, halogen-free

Terminals: Tin plated leads

Polarity: As marked

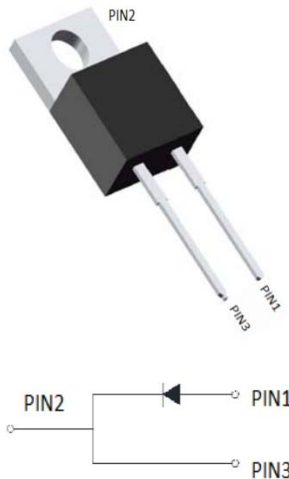

Maximum Ratings ($T_c=25$ Unless otherwise specified)

PARAMETER	SYMBOL	UNIT	VALUE
Device marking code			D106504PG1
Reverse voltage (repetitive peak) @ $T_j=25^\circ\text{C}$	V_{RRM}	V	650
Reverse voltage (Surge Peak) @ $T_j=25^\circ\text{C}$	V_{RSM}	V	650
Reverse voltage (DC) @ $T_j=25^\circ\text{C}$	V_{DC}	V	650
Continuous forward current @ $T_c=25^\circ\text{C}$	I_F	A	14
Continuous forward current @ $T_c=135^\circ\text{C}$			6.5
Continuous forward current @ $T_c=156^\circ\text{C}$			4
Non-repetitive peak forward surge current @ $T_c=25^\circ\text{C}$, $t_p=10\text{ms}$, Half Sine Wave	I_{FSM}	A	26
Power Dissipation @ $T_c=25^\circ\text{C}$	P_{TOT}	W	56
Power Dissipation @ $T_c=110^\circ\text{C}$			24
i^2t Value @ $T_c=25^\circ\text{C}$, $t_p=10\text{ms}$	i^2t	A^2S	3.3
Operating junction and Storage temperature range	T_j, T_{stg}	$^\circ\text{C}$	-55 to +175



Electrical Characteristics

PARAMETER	SYMBOL	UNIT	TEST CONDITIONS	Typ.	Max.
Forward voltage drop	V_F	V	$I_F=4A, T_J=25^\circ C$	1.4	1.55
			$I_F=4A, T_J=175^\circ C$	1.7	-
Reverse leakage current	I_R	μA	$V_R=650V, T_J=25^\circ C$	3	25
			$V_R=650V, T_J=175^\circ C$	20	-
Total capacitive charge	Q_C	nC	$V_R=400V, T_J=25^\circ C, Q_C = \int_0^{V_R} I_C(V) dV$	12	-
Total capacitance	C	pF	$V_R=0V, f=1MHz$	210	-
			$V_R=200V, f=1MHz$	24	-
			$V_R=400V, f=1MHz$	18	-
Capacitance Stored Energy	E_C	μJ	$V_R=400V$	1.5	-

Thermal Characteristics ($T_a=25$ Unless otherwise specified)

PARAMETER	SYMBOL	UNIT	Value
Thermal resistance	R_{J-C}	$^\circ C/W$	2.65

Typical Characteristics

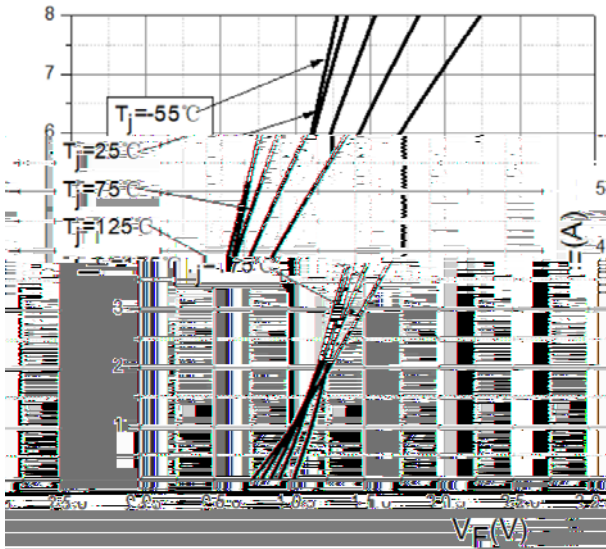

Figure 1. Forward Characteristics

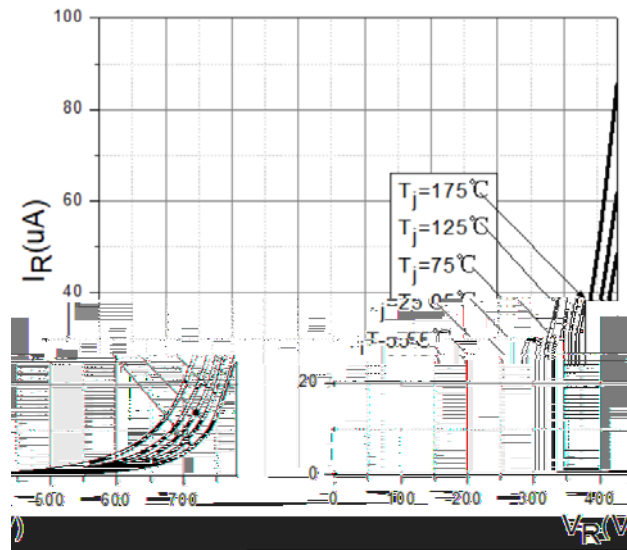

Figure 2. Reverse Characteristic

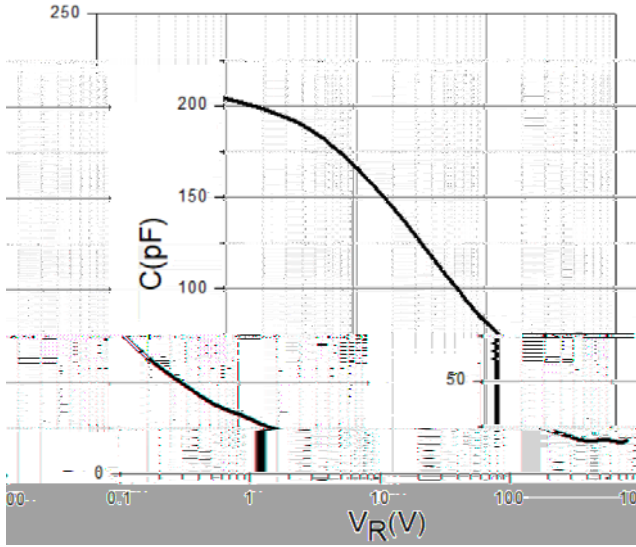

Figure 3. Capacitance vs. Reverse Voltage

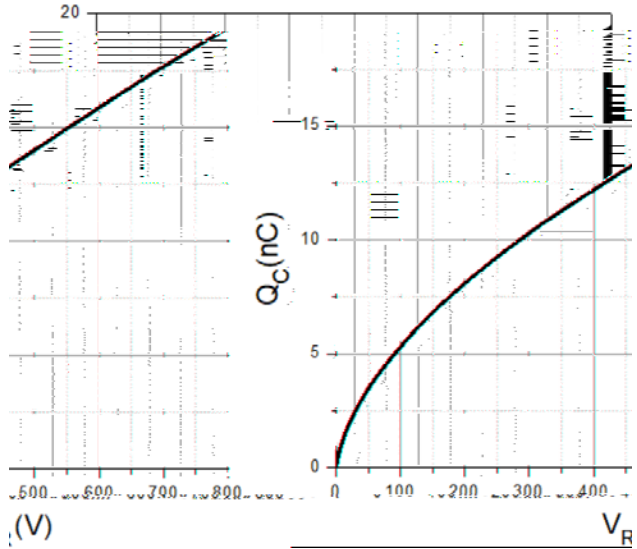

Figure 4. Total Capacitance Charge vs. Reverse Voltage

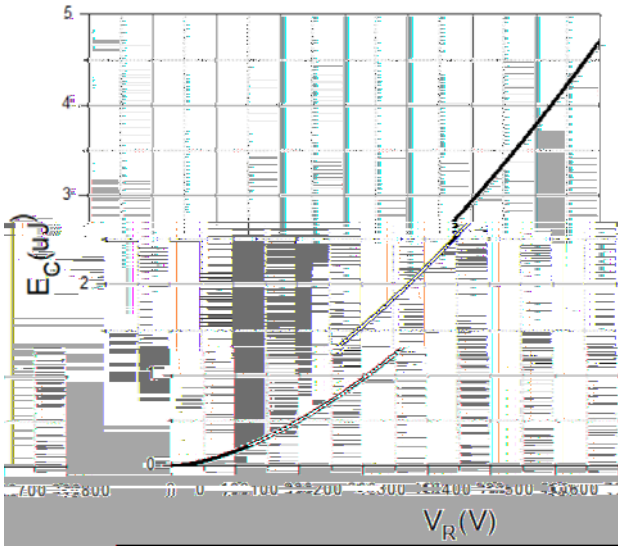

Figure 5. Capacitance Stored Energy

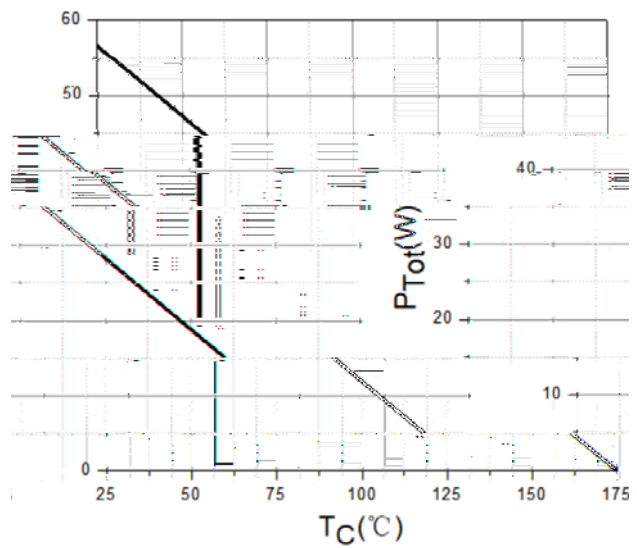

Figure 6. Power Derating

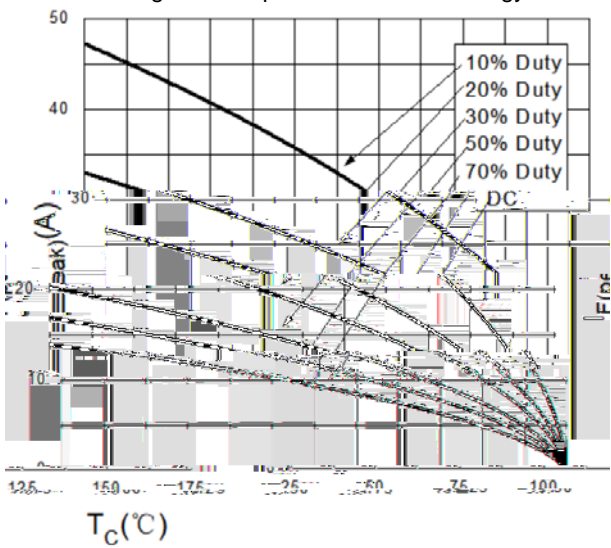

Figure 7. Current Derating

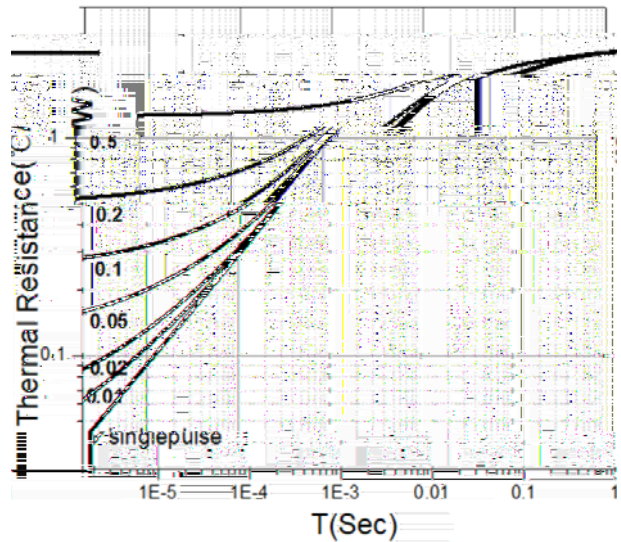
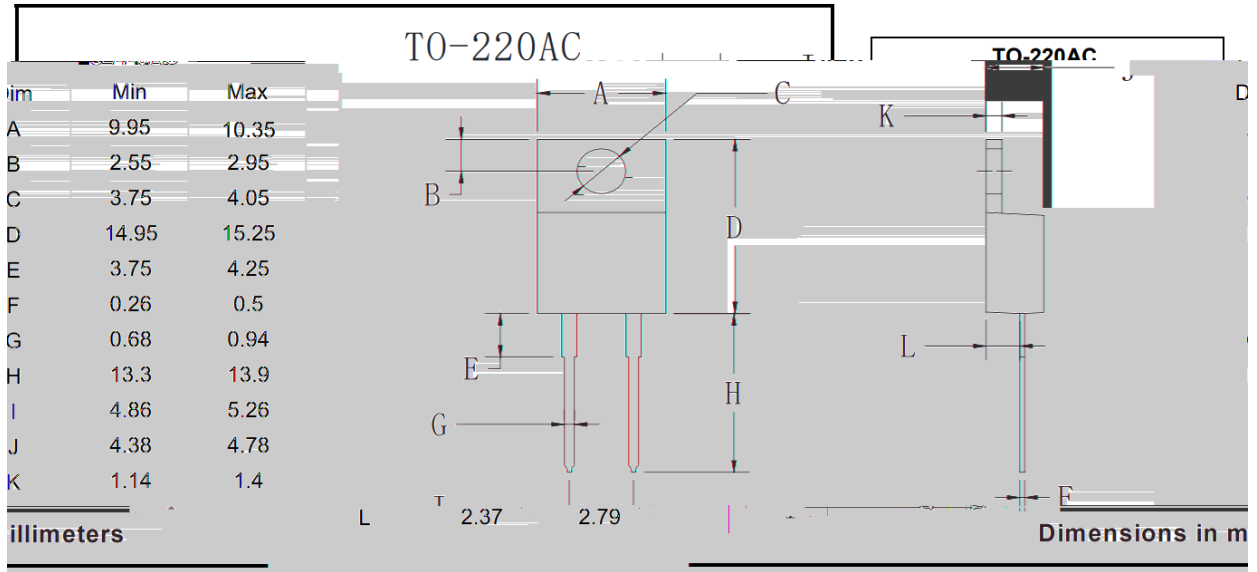

Figure 8. Transient Thermal Impedance



Outline Dimensions





Disclaimer

The information presented in this document is for reference only. Yangzhou Yangjie Electronic Technology Co., Ltd. reserves the right to make changes without notice for the specification of the products displayed herein to improve reliability, function or design or otherwise.

The product listed herein is designed to be used with ordinary electronic equipment or devices, and not designed to be used with equipment or devices which require high level of reliability and the malfunction of which would directly endanger human life (such as medical instruments, transportation equipment, aerospace machinery, nuclear-reactor controllers, fuel controllers and other safety devices), Yangjie or anyone on its behalf, assumes no responsibility or liability for any damages resulting from such improper use of sale.

This publication supersedes & replaces all information previously supplied. For additional information, please visit our website [http:// www.frxelec.com](http://www.frxelec.com) , or consult your nearest Yangjie's sales office for further assistance.