



深圳市弗瑞鑫电子有限公司

规格承认书

—
————
————

prepare	
check	
approve	



TRX电容一级代理商

深圳市弗瑞鑫电子有限公司

Add:深圳市宝安区西乡大道302号金源商务大厦B座3楼

Tel:0755-29563634

Fax:0755-27447020

- 2

2 . .

/

/

/

/

	- 2 2 . .		
	/		/
	/		/

 TRX 专注电容器廿年	- 2 2 . .		
	/		/
	/		/

1. /

① ② ③ ④ ⑤ ⑥

①		
②		
③		
④		×
⑤		
⑥		±

2. /

	 TRX TL E 102M X1 440V~
--	---

	- 2 2 . .		
	/		/
	/		/

3. /



4. /

5. /

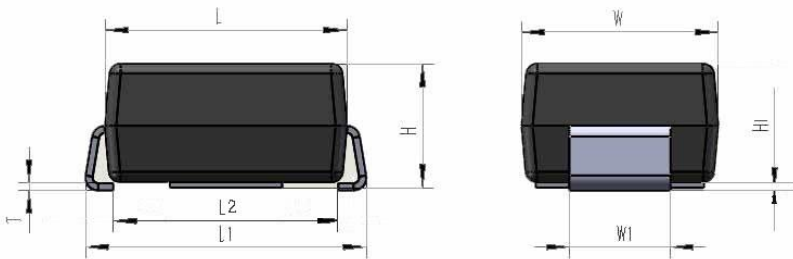

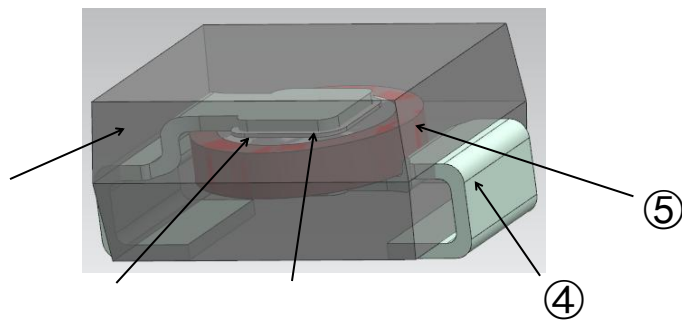

①		
②		
③		
④		
⑤		

- 2
2 ..

/

/

/

/

	- 2 2 . .		
	/		/
	/		/

/

°
°C

°

°

°

/

7. /

	- 2 2 . .		
	/		/
	/		/





- 2
2 ..

/

/

/

/

					±
		±			
		±			
		±			
		±			

			± ±
			± ± ±
			± ± ±

8. /

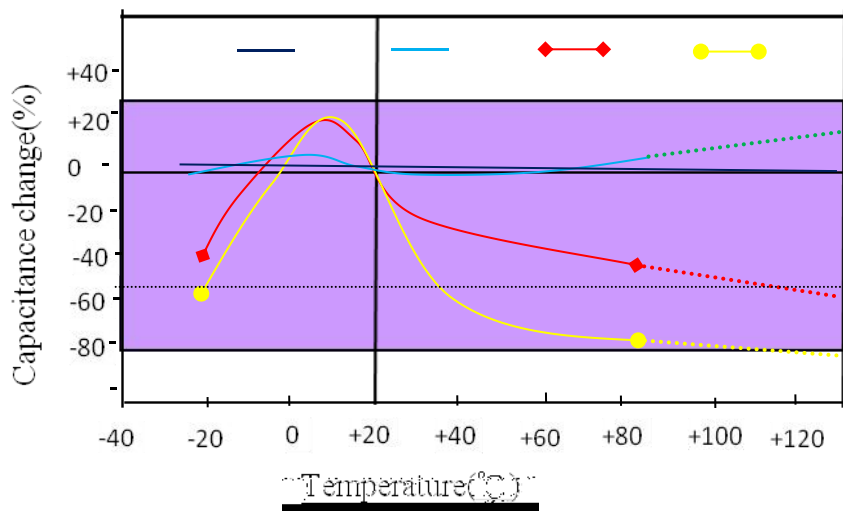

11. /
/

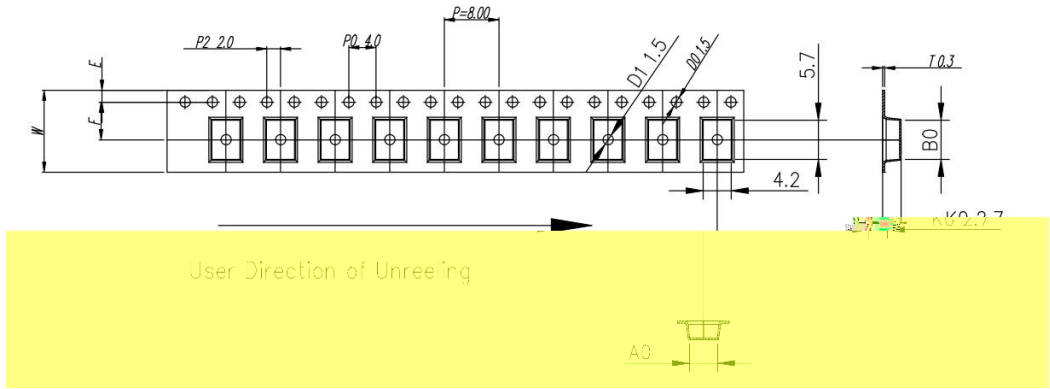



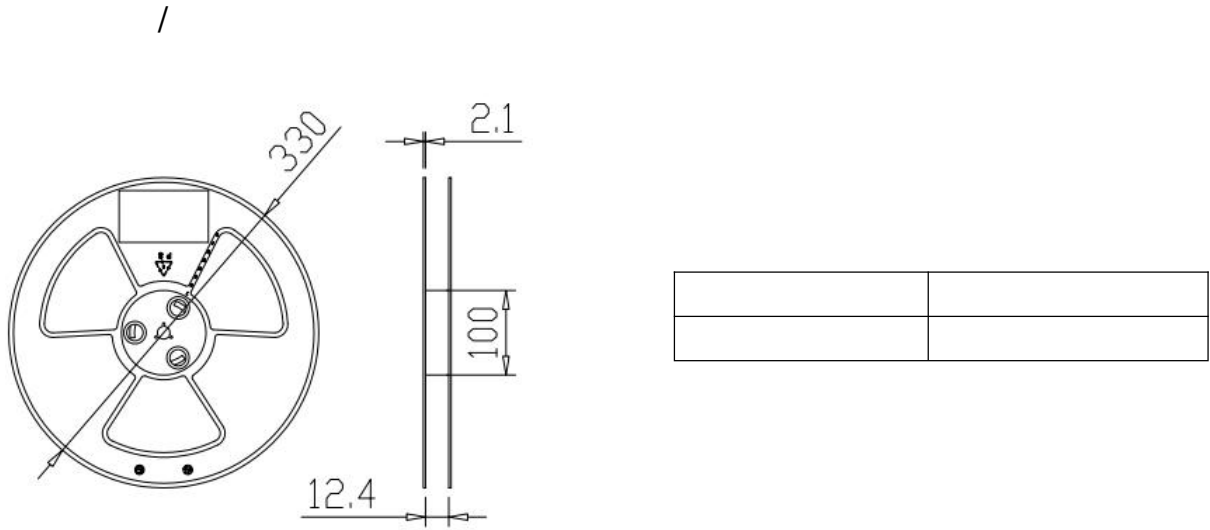

ITEM	W	A0	B0	K1	K0	P	F	E	D0	D1	P0	P2	T
DIM	12.0	4.8 ± 0.10	5.70 ± 0.10	--	2.70 ± 0.10	8.00 ± 0.10	5.50 ± 0.10	1.75 ± 0.10	$\phi 1.5 \pm 0.05$	$\phi 1.5 \pm 0.10$	4.00 ± 0.10	2.00 ± 0.10	0.30 ± 0.05
ALTERNATE													

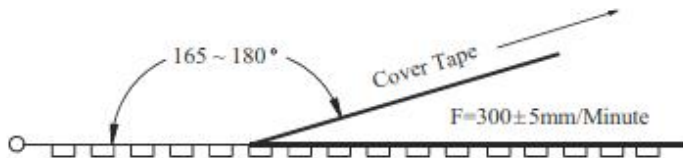

/

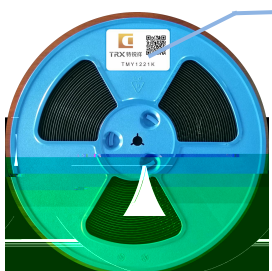
Item	Data	Remark
Cover tape adhesion	10 ~ 100g	Carrier tape and cover tape open angle 165 ~ 180° F=300±5mm/minute

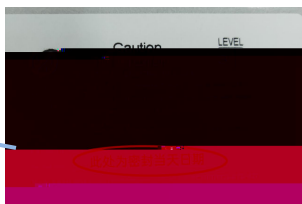

/ -	 <p style="margin-left: 10px;">标签</p>	 <p style="margin-left: 10px;">料号</p>	
			

/ -											
	图示 /	图示 /	图示 /								
	<table border="1" style="width: 100%; border-collapse: collapse;"> <tr> <td style="width: 25%; height: 20px;"></td> <td style="width: 25%; height: 20px;"></td> <td style="width: 25%; height: 20px;"></td> <td style="width: 25%; height: 20px;"></td> </tr> <tr> <td style="width: 25%; height: 20px;"></td> <td style="width: 25%; height: 20px;"></td> <td style="width: 25%; height: 20px;"></td> <td style="width: 25%; height: 20px;"></td> </tr> </table>										

/	:	
		
/	/	

" "

	- 2 2 . .		
	/		/
	/		/

12. /

①

②