

一级代理商：

深圳市弗瑞鑫电子有限公司

地址：深圳市宝安区西乡大道302号金源商务大厦B座三楼

0 -

0 - 0 0

.frxelec.

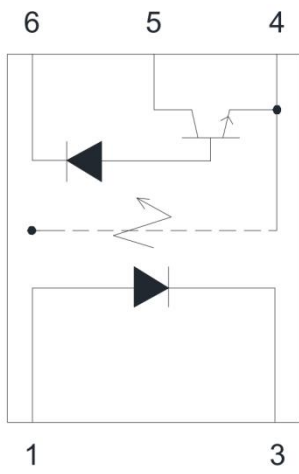
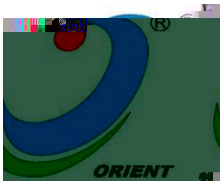

- 1. Anode
- 3. Cathode
- 4. GND
- 5. Vo (Output)
- 6. Vcc

()	

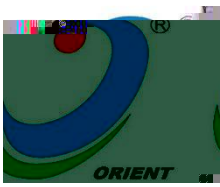

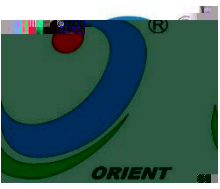

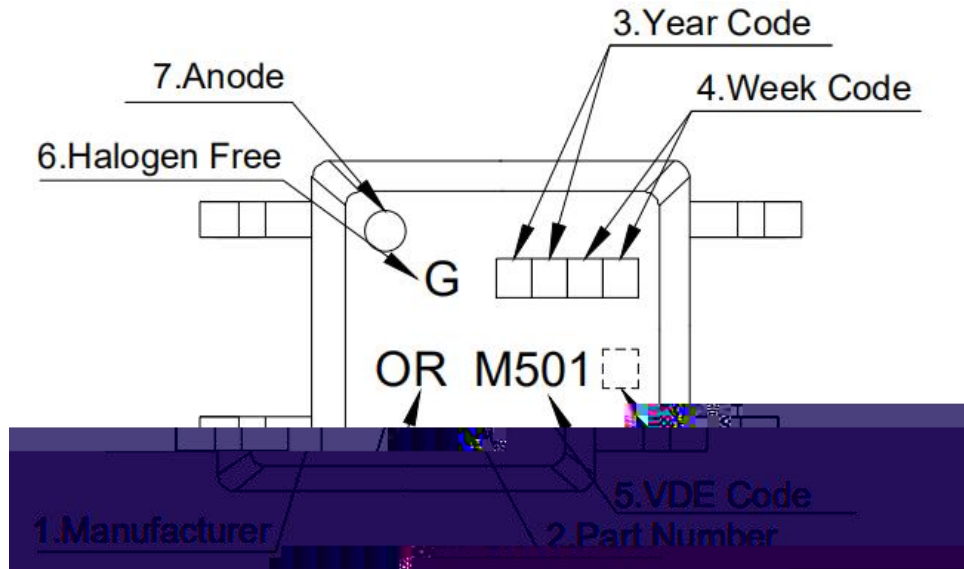
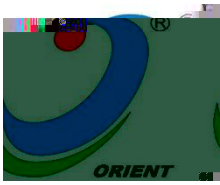

□□ :

□□ :

□

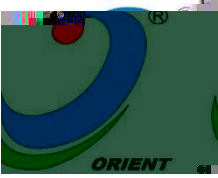

()

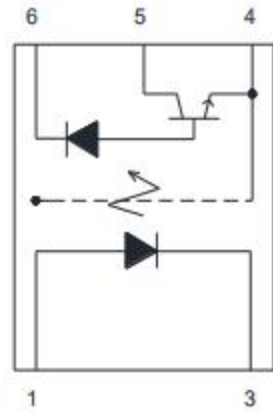
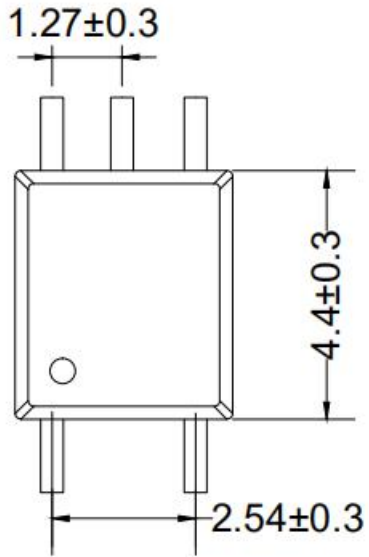

- 1. Anode
- 3. Cathode
- 4. GND
- 5. Vo(Output)
- 6. Vcc

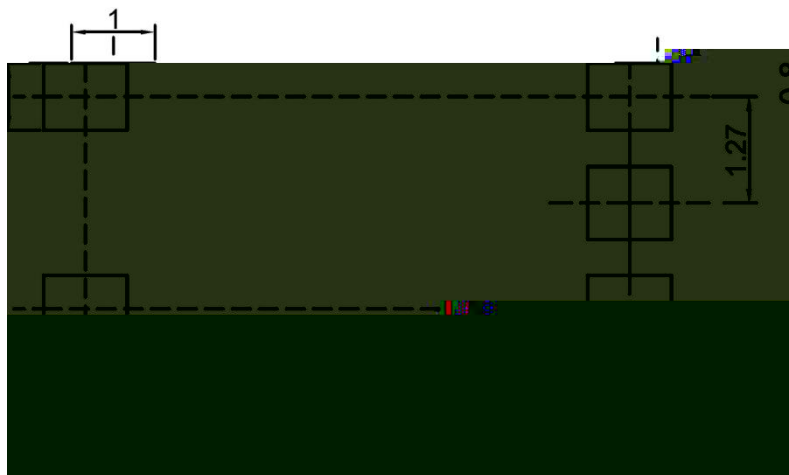
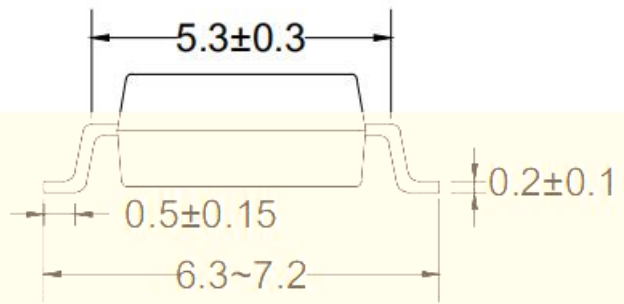
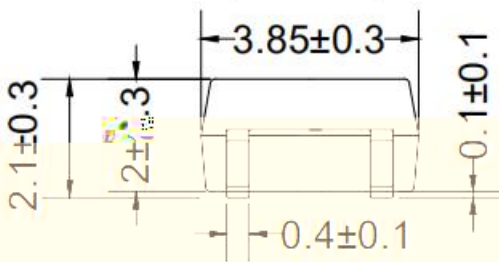

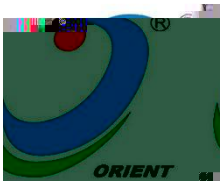

()

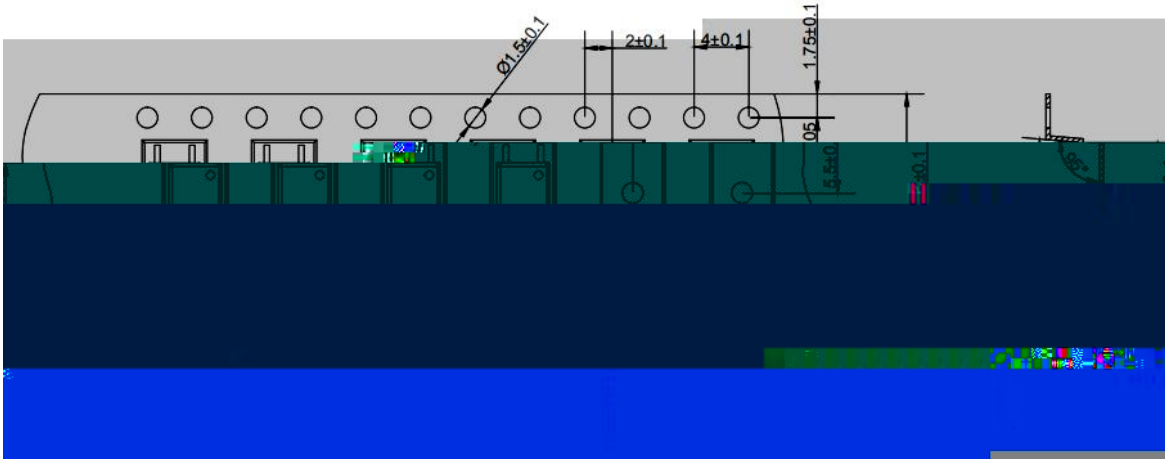

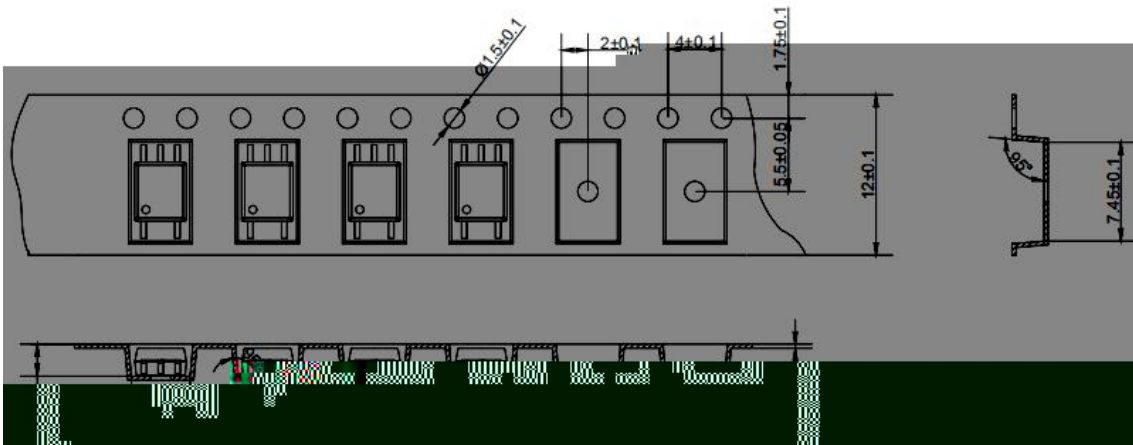

()



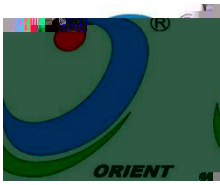

		()
		()
		()
		()
		()

()	



 **ORIENT**
ShenZhen Orient
Components Co.,LTD

Material Code : 120PCXXXXXX

|||||

P/N: OR-XXXXXX

|||||

内箱码 外箱码

Lot No. : XXXXX-XXXXX-1A-X

|||||

D/C: XXXX

|||||

Qty: XXXX PCS

“XXXXXXXXXXXXXXXX” (一体机序列号)

|||||

Made in China

:

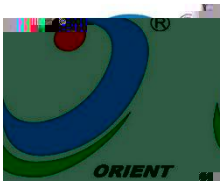

	焊接热			次	炉	
	温存储				温烤 测 仪	
	低温存储				低温 测 仪	
	温度循				冷热冲 击机	
	温度冲击				冷热冲 击机	
	温操作				温烤 测 仪、 化板	
	人体模式			次	测 仪	
	可焊性			次	炉	
	温湿寿命				恒温恒湿 机, 测 仪	
	压力				压力	

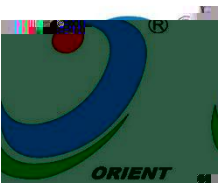

()

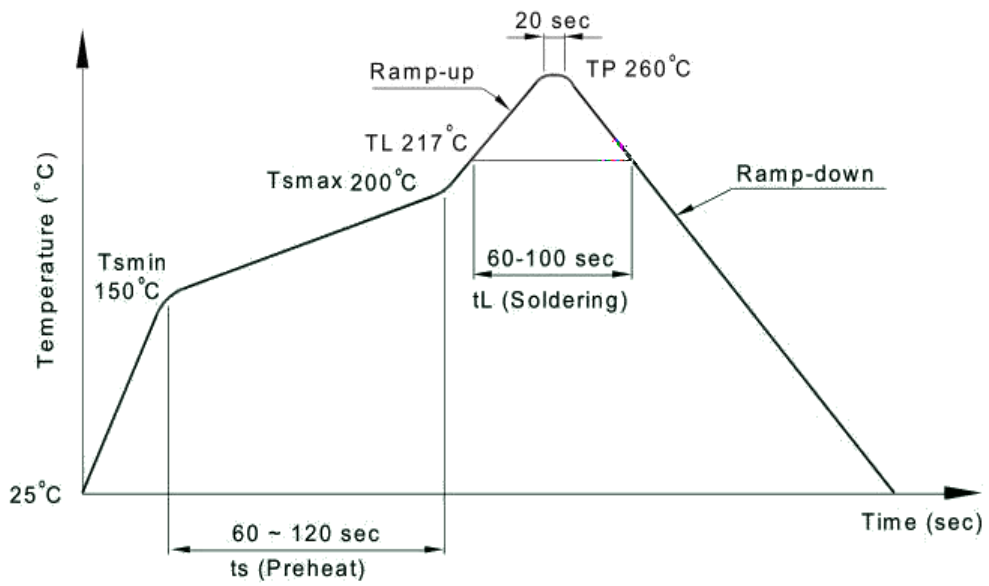

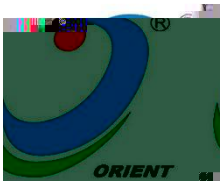

()

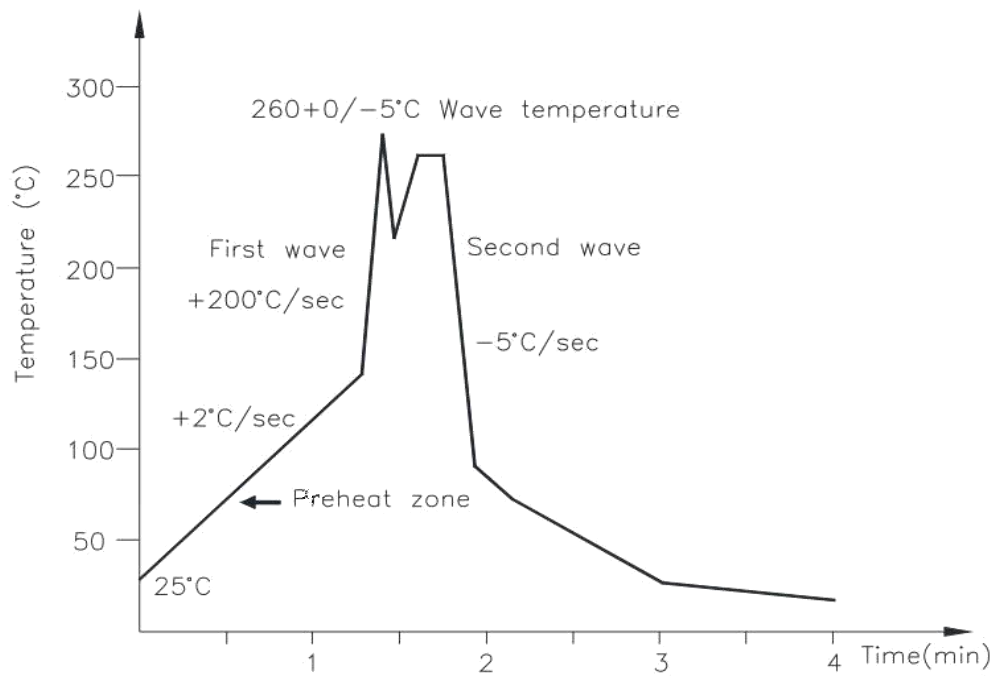

()

--	--

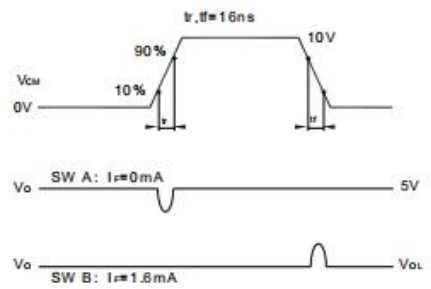
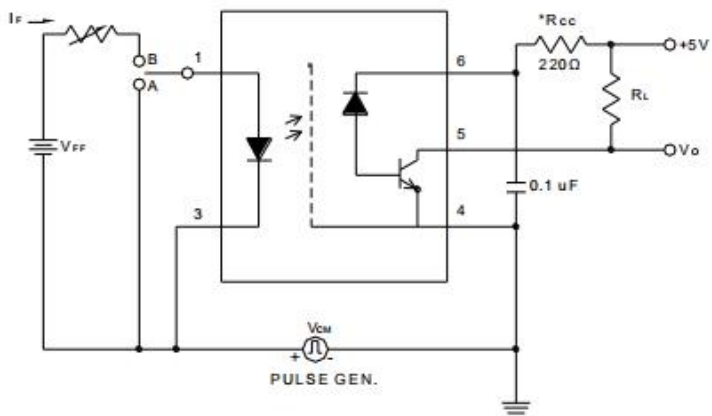
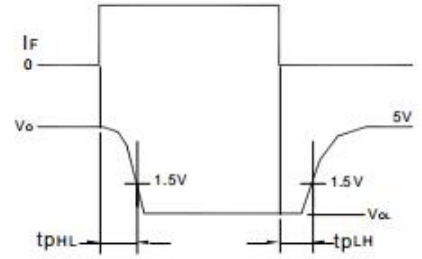
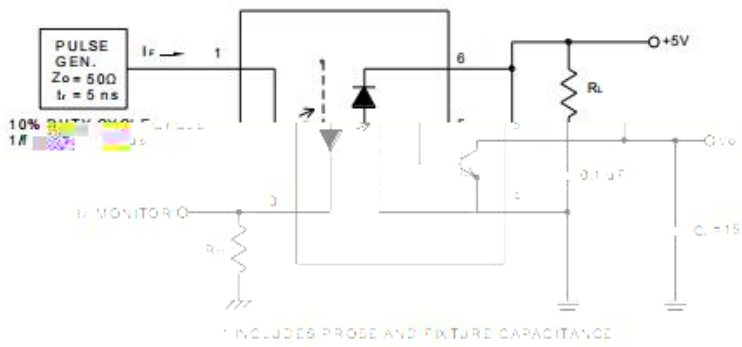
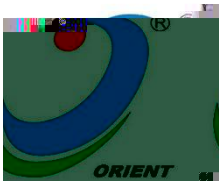

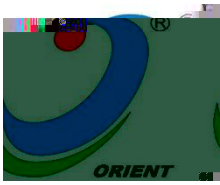

Figure 3: DC and pulsed transfer characteristics

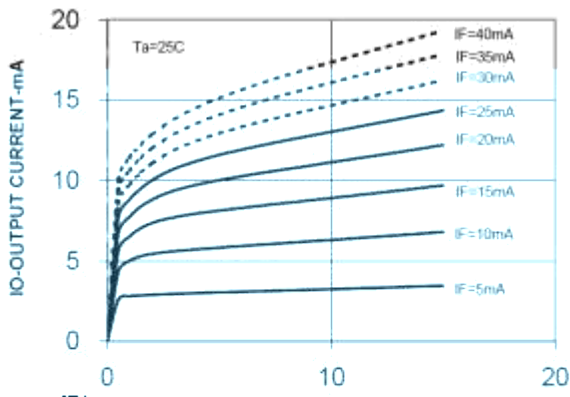

Figure 6: Current transfer ratio vs. input current

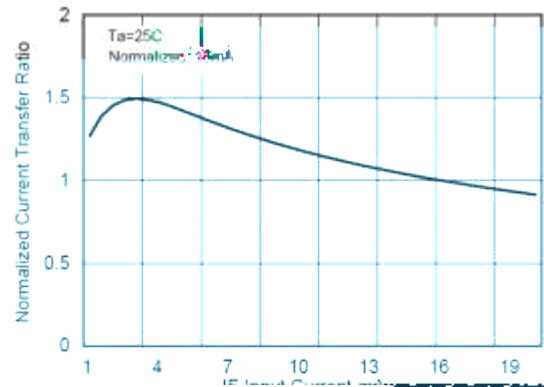

Figure 7. NORMALIZED CURRENT TRANSFER RATIO VS. AMBIENT TEMPERATURE

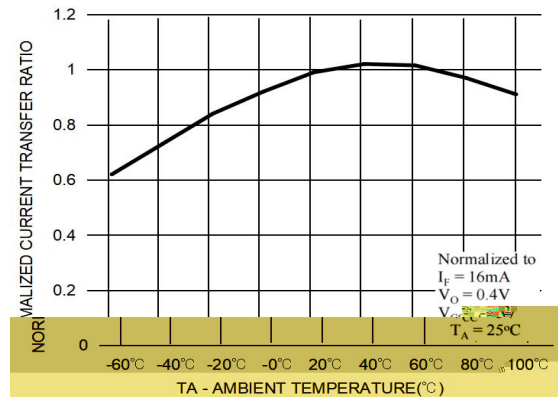

Figure 5: Logic high output current vs. temperature

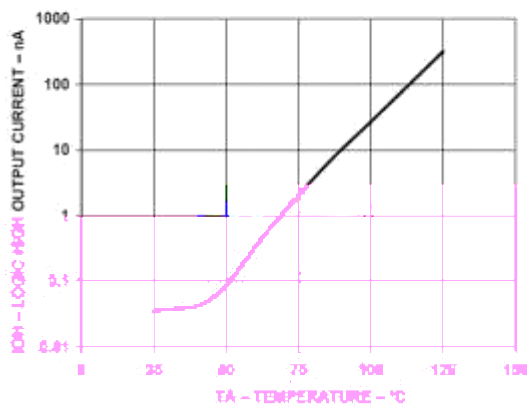
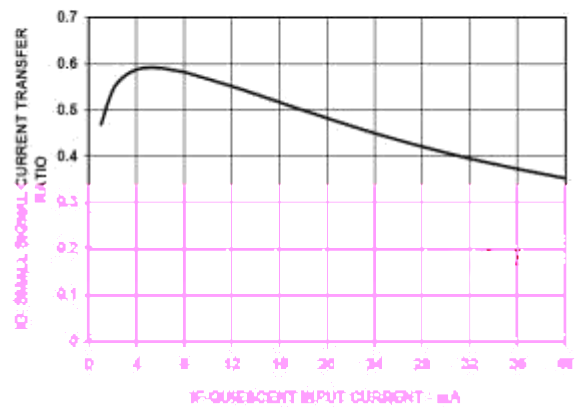

Figure 8: Small-signal current transfer ratio vs. quiescent current



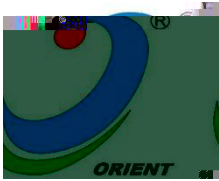

Figure 9: Propagation delay time vs. temperature

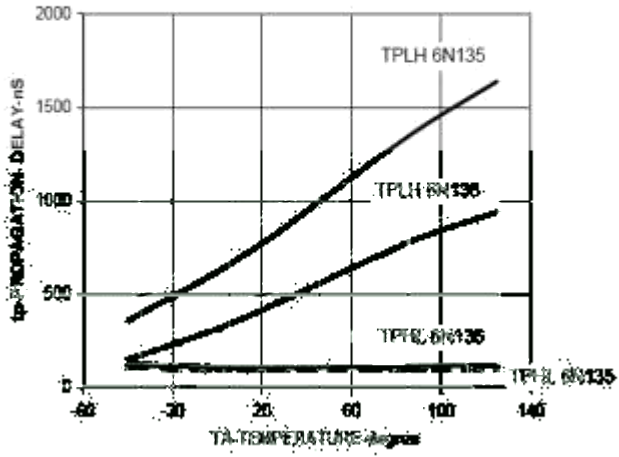

Figure 10: Propagation delay time vs. load resistance

