



深圳市弗瑞鑫电子有限公司

规格承认书

—

prepare	
check	
approve	



TRX电容一级代理商

深圳市弗瑞鑫电子有限公司

Add:深圳市宝安区西乡大道302号金源商务大厦B座3楼

Tel:0755-29563634

Fax:0755-27447020

	2 2 . .		
	/		/
	/		/

	2 $2 \dots$		
	/		/
	/		/

1. /

$\overline{\text{①}}$ $\overline{\text{②}}$ $\overline{\text{③}}$ $\overline{\text{④}}$ $\overline{\text{⑤}}$ $\overline{\text{⑥}}$

①

	2 2 . .		
	/		/
	/		/

3. /



4. /

5. /



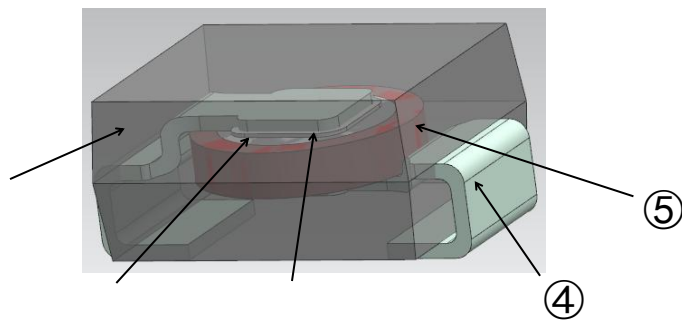

①		
②		
③		
④		
⑤		

2
2 . .

/

/

/

	2 2 . .		
	/		/
	/		/

/

°
°C

°

°

°

/

7. /

	2 2 . .		
	/		/
	/		/



 TRX 专注电容器廿年	2		
	2 . .		
	/		/
	/		/

8. /

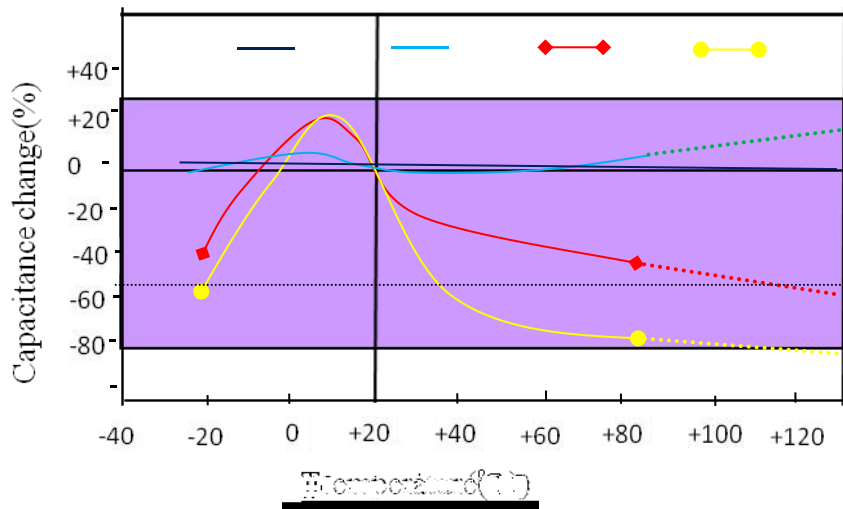

11. /
/

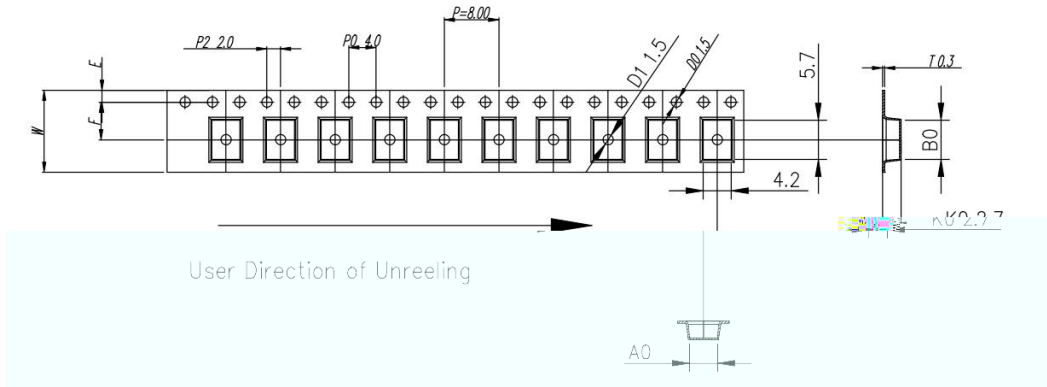

ITEM	W	A0	B0	K1	K0	P	F	E	D0	D1	P0	P2	T
DIM	12.0 ± 0.30	4.2 ± 0.10	5.70 ± 0.10	--	2.70 ± 0.10	8.00 ± 0.10	5.50 ± 0.10	1.75 ± 0.10	$\phi 1.5$ ± 0.05	$\phi 1.5$ ± 0.10	4.0 ± 0.10	2.0 ± 0.10	0.30 ± 0.05
ALTERNATE													

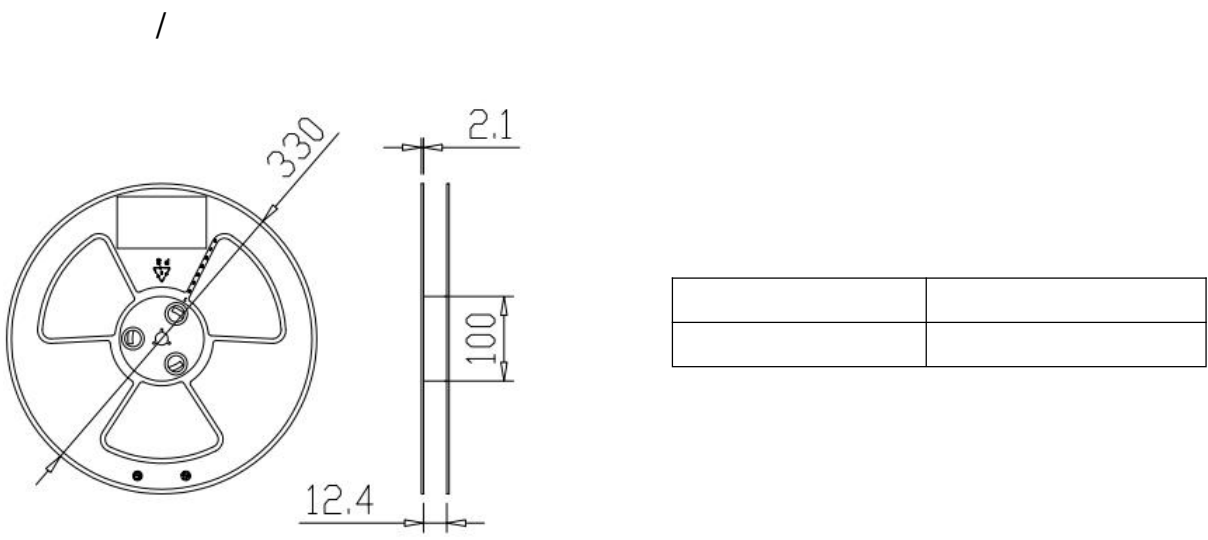

Item	Data	Remark
Cover tape adhesion	10 ~ 100g	Carrier tape and cover tape open angle 165 ~ 180° F=300±5mm/minute

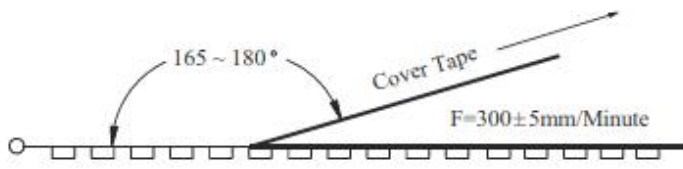

 TRX 专注电容器廿年	2 2 . .			
	/		/	
	/		/	

/ -

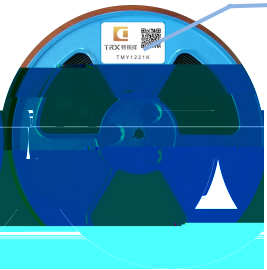

标签



料号

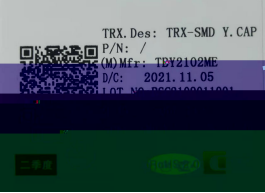



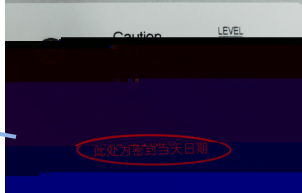

/ -





图示 /



图示 /



图示 /

/ :



/



/





--	--

	2 2 . .		
	/		/
	/		/

12. /

①

②