

深圳市弗瑞鑫电子有限公司

规格承认书

—

prepare	
check	
approve	



TRX电容一级代理商
深圳市弗瑞鑫电子有限公司

Add: 深圳市宝安区西乡大道302号金源商务大厦B座3楼
Tel: 0755-29563634
Fax: 0755-27447020

 TRX 专注电容器廿年	SMD Y SMD Y1 a.c. ceramic capacitors			
	/Number		/Date	
	/Edition		/Page	

	SMD Y SMD Y1 a.c. ceramic capacitors		
	/Number		/Date
	/Edition		/Page

1. /Product Name

T M Y1 101 K
 ① ② ③ ④ ⑤

①		
②		
③		
④		
⑤		

2. /Product marking

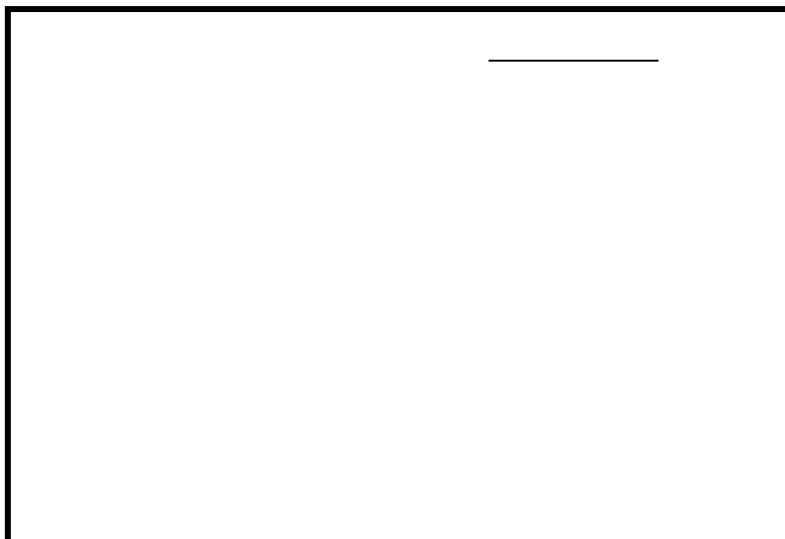
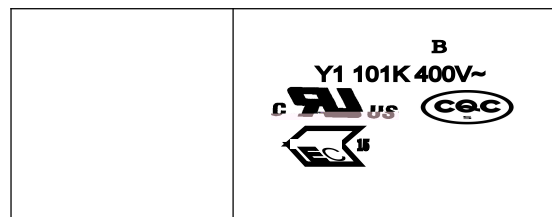

4. /Certificates

certificates			

5. / Product structure

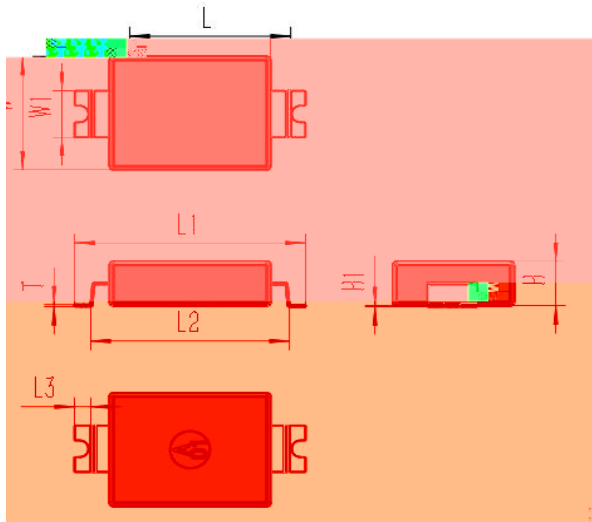

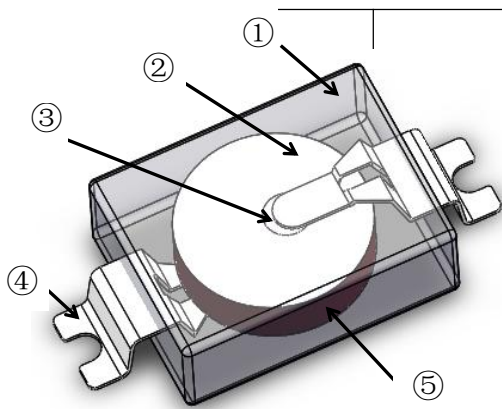

(4)		
(5)		

	SMD Y SMD Y1 a.c. ceramic capacitors		
	/Number		/Date
	/Edition		/Page

/

°
°C
°
°
°

/

7. / Performance and test methods

 TRX 专注电容器廿年	SMD Y SMD Y1 a.c. ceramic capacitors			
	/Number		/Date	
	/Edition		/Page	





SMD Y
SMD Y1 a.c. ceramic capacitors

/Number

/Date

/Edition

/Page

		△	
		△	
		△	
		△	
		△	
		△	
		△	
		△	
		△	
		△	

SMD Y
SMD Y1 a.c. ceramic capacitors





/Number

/Date

/Edition

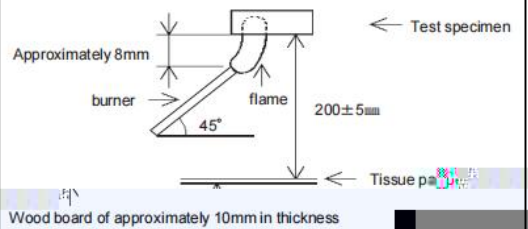
/Page



 TRX 专注电容器廿年	SMD Y SMD Y1 a.c. ceramic capacitors		
	/Number		/Date
	/Edition		/Page



R

11. /Product Packing

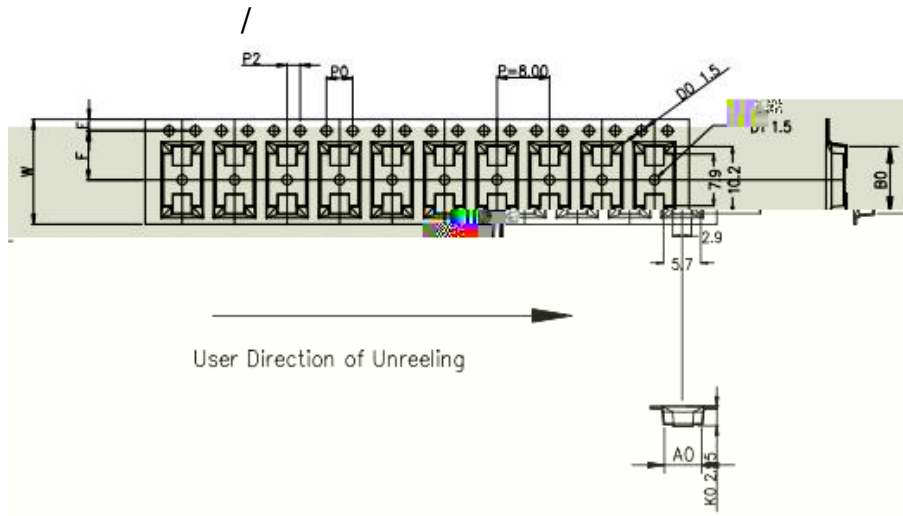

ITEM	Δ W	A0	B0	K1	K0	P	F	E	D0	D1	P0	P2	T
DIM	16.0 +0.30 -0.10	5.70 +0.10 -0.10	10.20 +0.10 -0.10	---	2.95 +0.10 -0.10	8.00 +0.10 -0.10	7.50 +0.10 -0.10	1.75 +0.18 -0.10	1.5				
ALTERNATE													

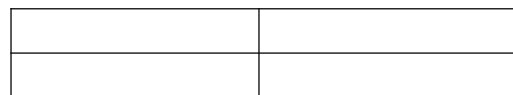
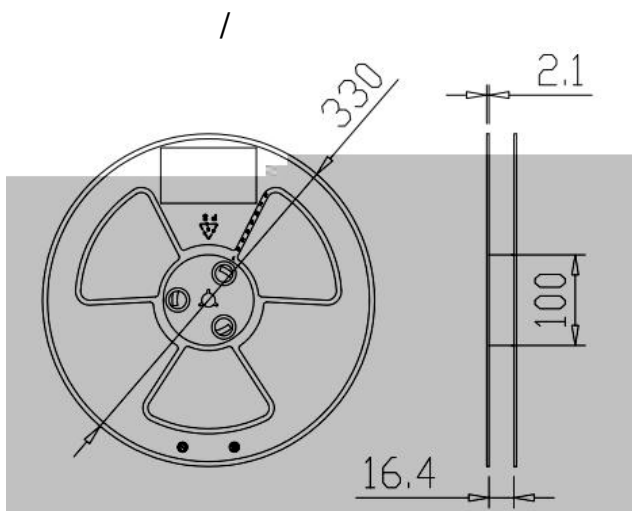

Item	Data	Remark
Cover tape adhesion	10 ~ 100g	Carrier tape and cover tape open angle 165 ~ 180° F=300±5mm/minute

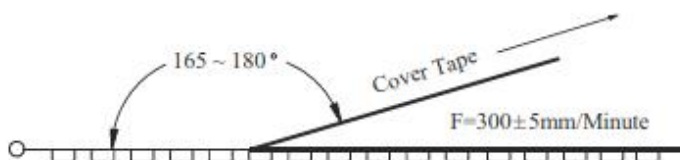

 TRX 专注电容器廿年	SMD Y SMD Y1 a.c. ceramic capacitors		
	/Number		/Date
	/Edition		/Page

/inner-packaging



标签



料号



TRX Des: TRX-SMD Y. CAP



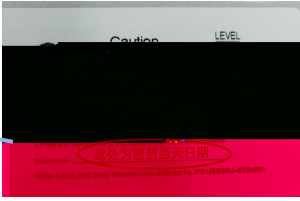

此处为密封自天日期

/Outer-packaging





图示 /



图示 /



图示 /

/Package sketch:



/



/





Remark

	SMD Y SMD Y1 a.c. ceramic capacitors			
	/Number		/Date	
	/Edition		/Page	

12. /Application notes

①

②

③

④

⑤

⑥