



一级代理商：

深圳市弗瑞鑫电子有限公司

地址：深圳市宝安区西乡大道302号金源商务大厦B座三楼

0 -

0 - 0 0

.frxelec.

%"

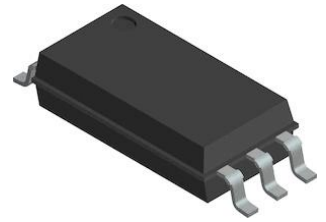

&"

"

("

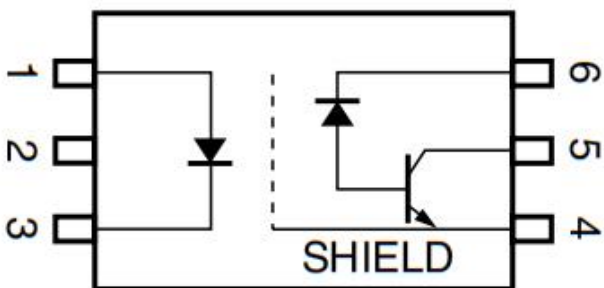

1. Anode
2. NC
3. Cathode
4. GND
5. V_o
6. V_{cc}

)"



* II



+

"
,

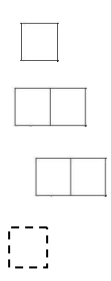
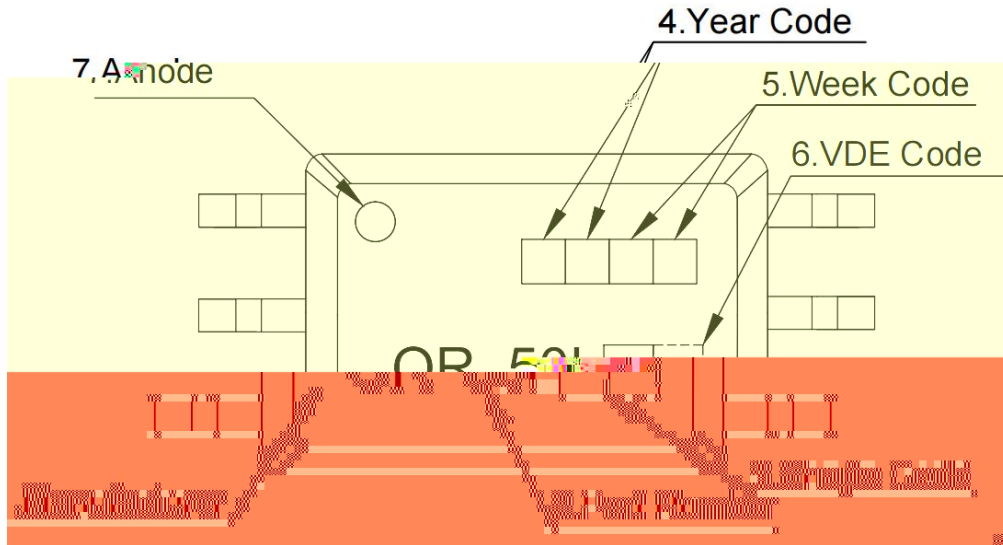

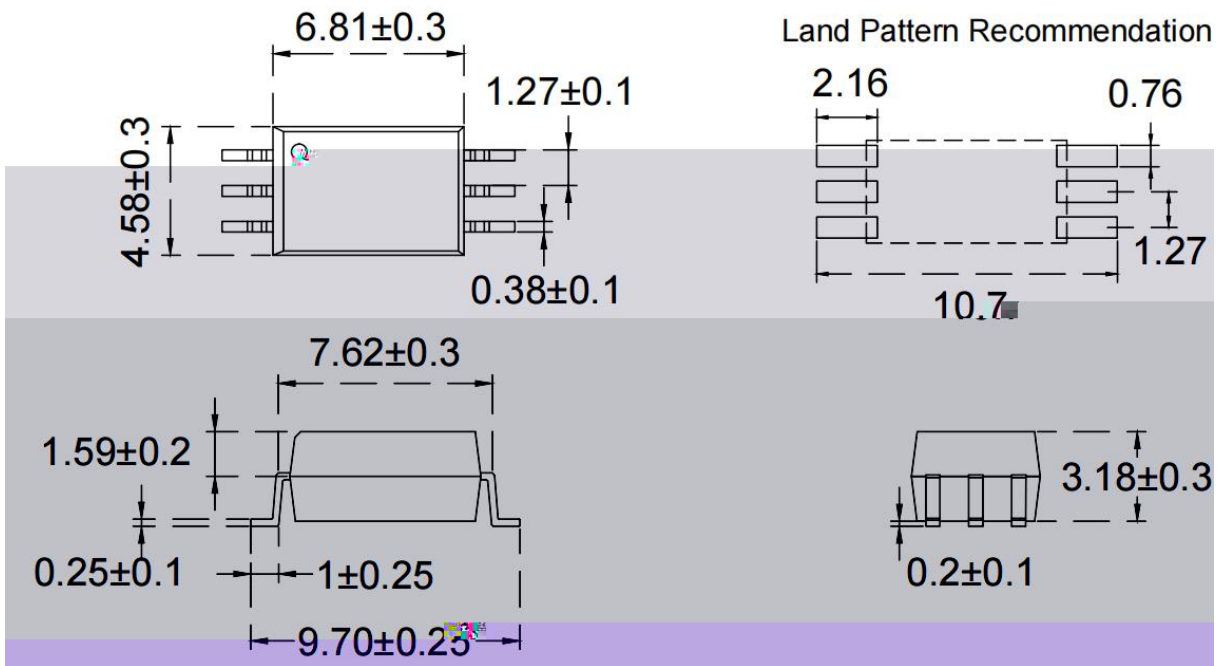
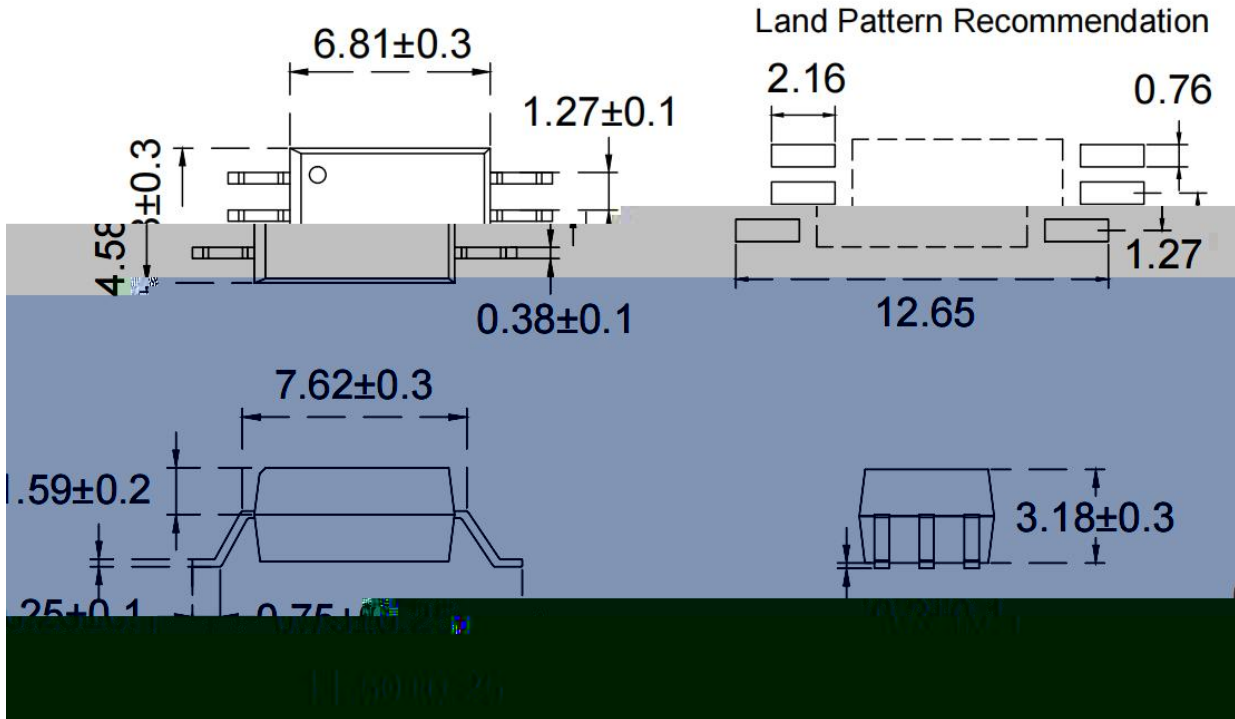



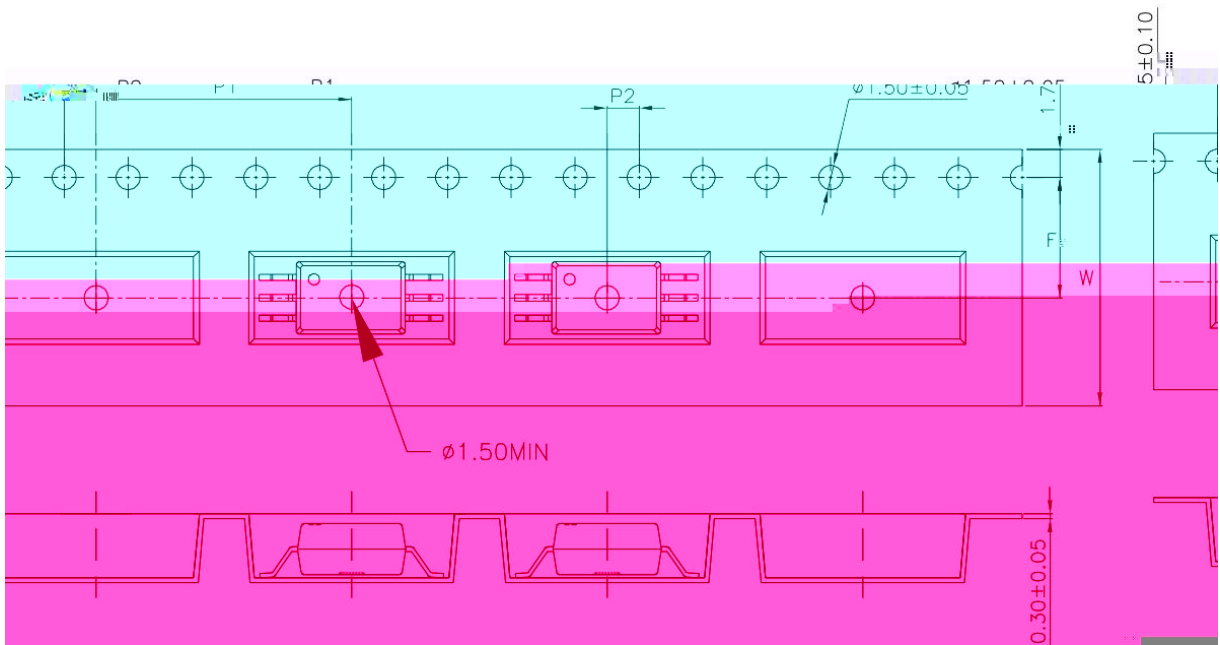
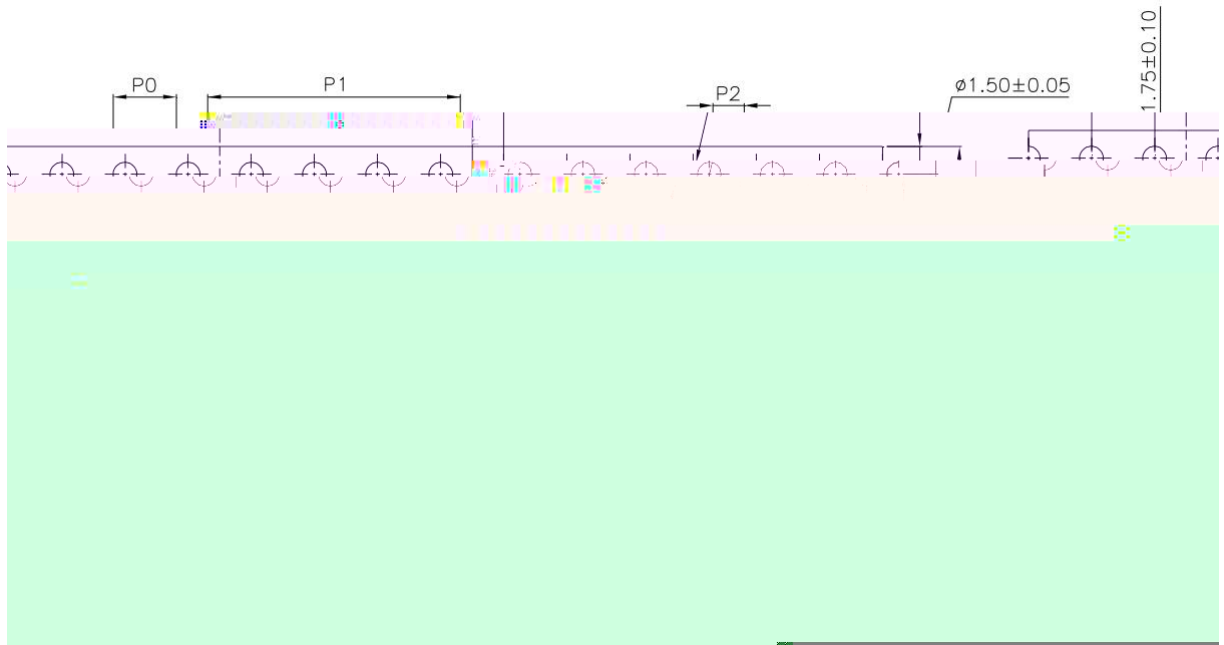

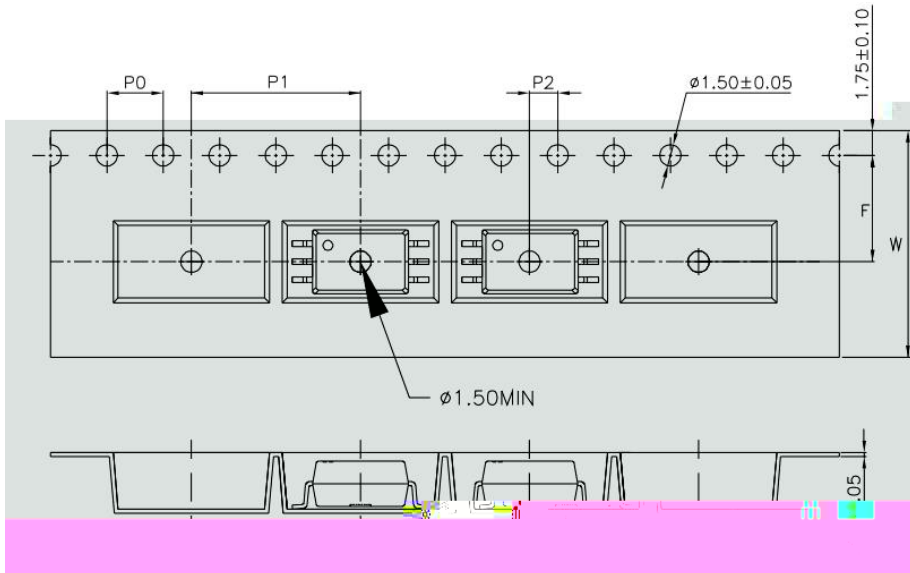
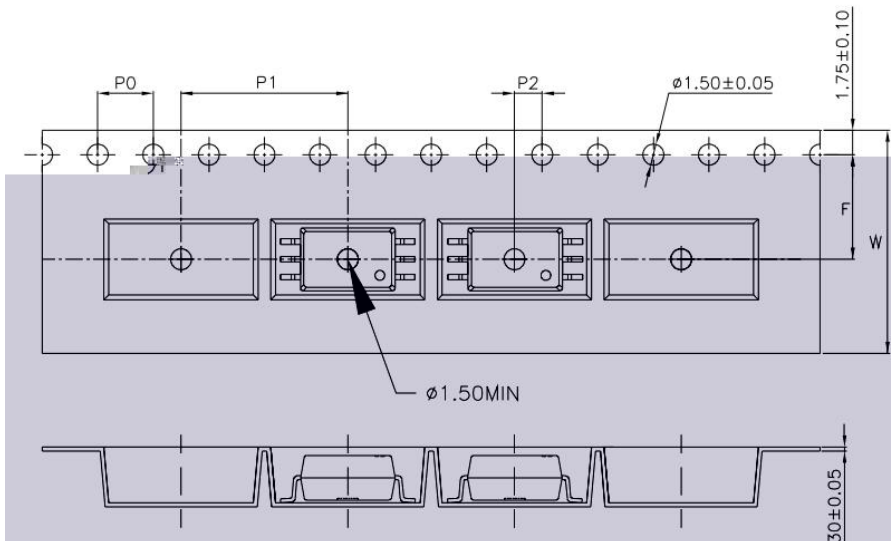
%"\$"







%%"

 <p>ShenZhen Orient Components Co.,LTD</p>	  		
Material Code : 120PCYXXXXX P/N : OR-XXXXX Lot No. : XXXXXX-XXXXX-TX-X D/C : XXXX Qty : XXXX PCS 	<table border="1"><tr><td>内箱码</td><td>外箱码</td></tr></table> <p>“XXXXXXXXXXXXXXXX” (一体机序列码) Made in China</p>	内箱码	外箱码
内箱码	外箱码		

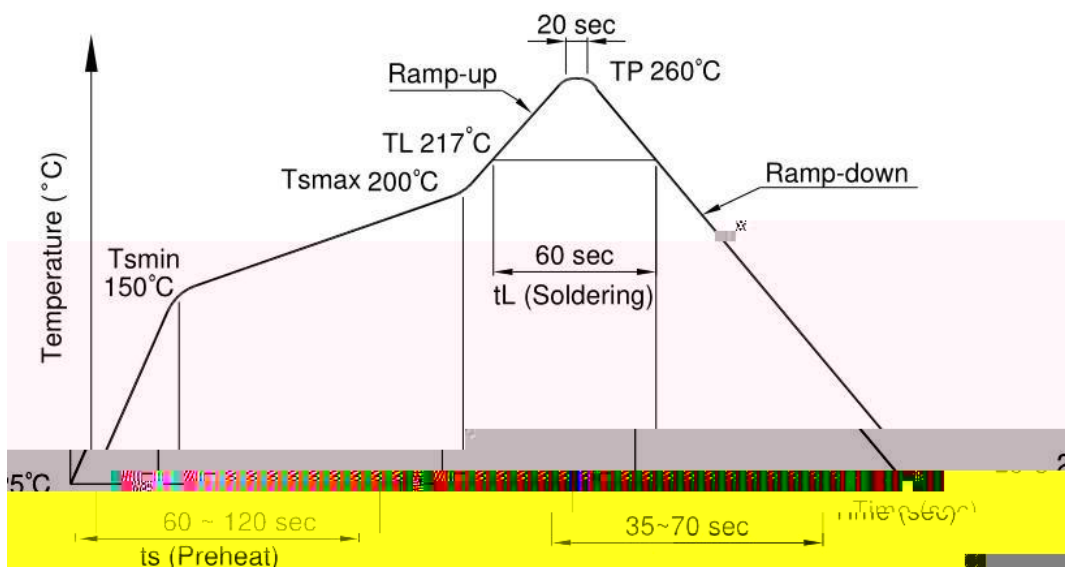

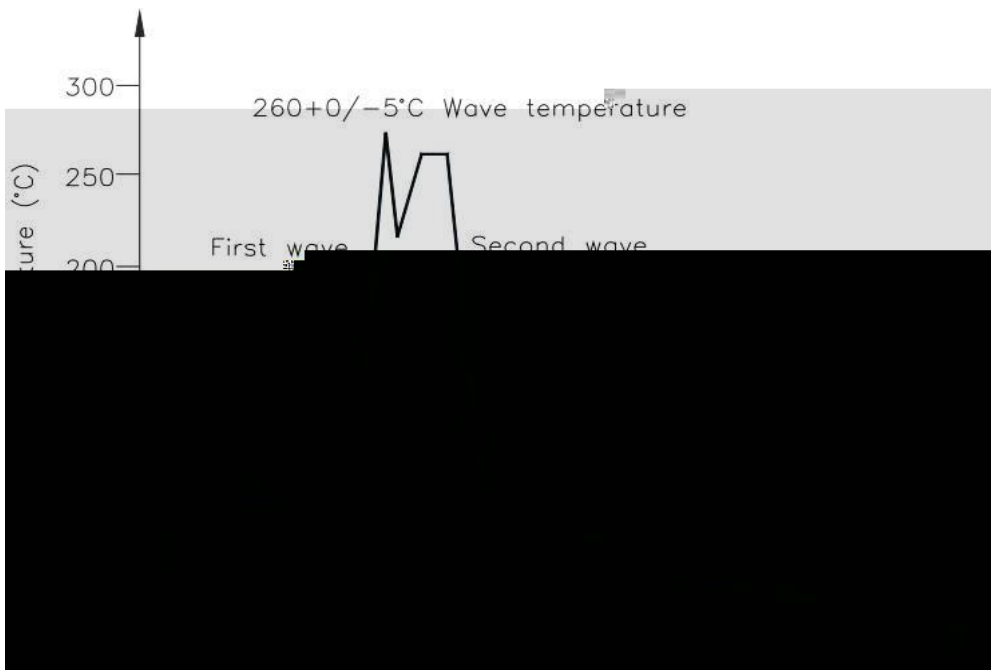

--	--

% ("

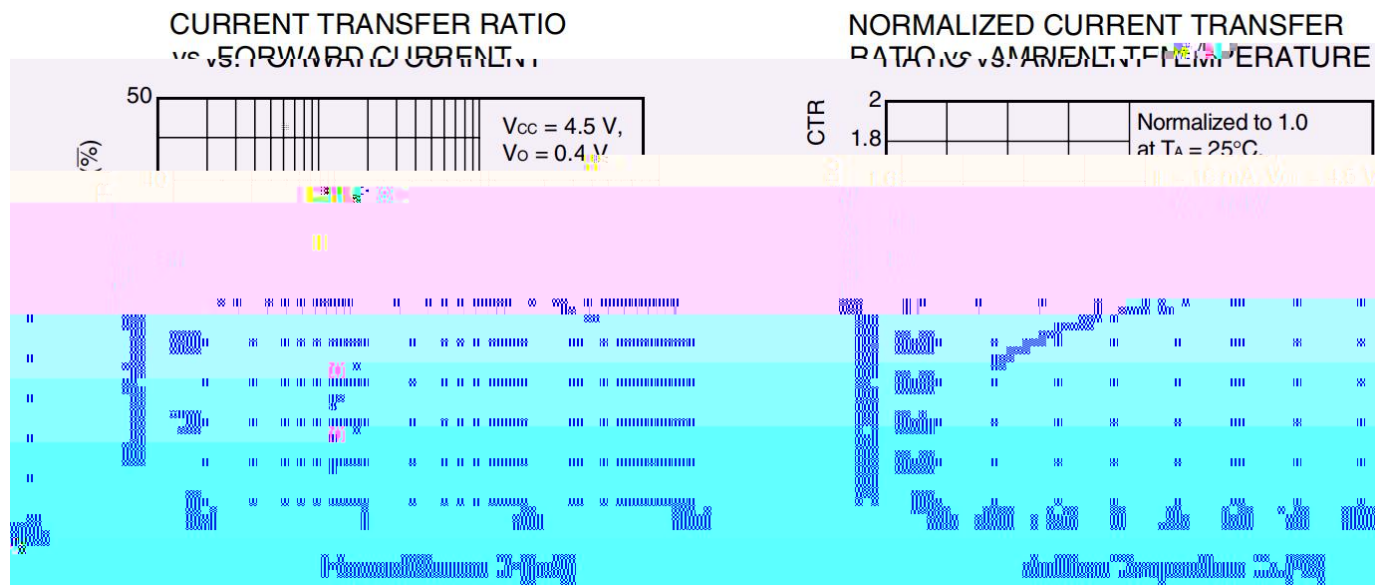
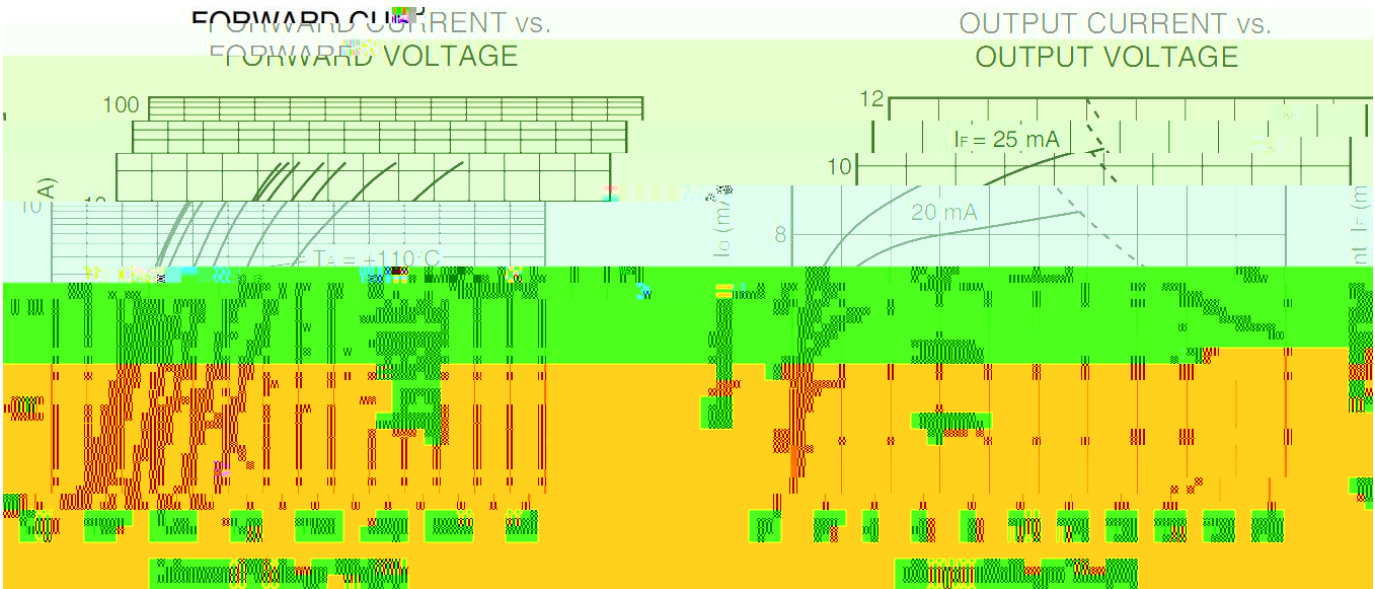
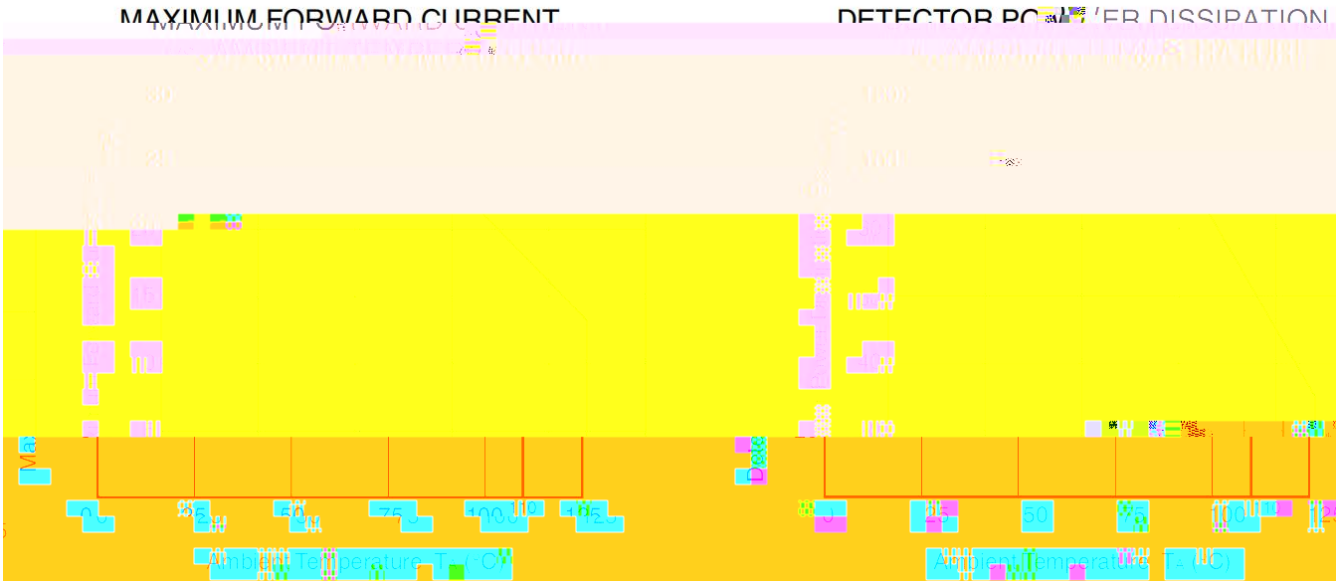

OUTPUT VOLTAGE vs. FORWARD CURRENT

HIGH LEVEL OUTPUT CURRENT vs. AMBIENT TEMPERATURE



PROPAGATION DELAY TIME vs. LOAD RESISTANCE

PROPAGATION DELAY TIME vs. AMBIENT TEMPERATURE

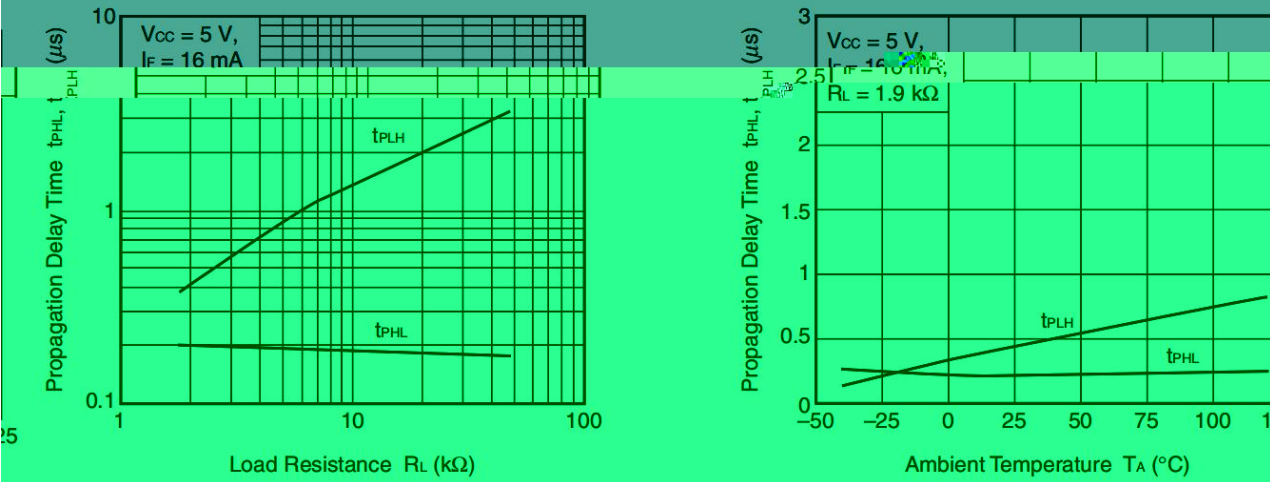

Test circuit for propagation delay time



Test circuit for common mode transient immunity

